

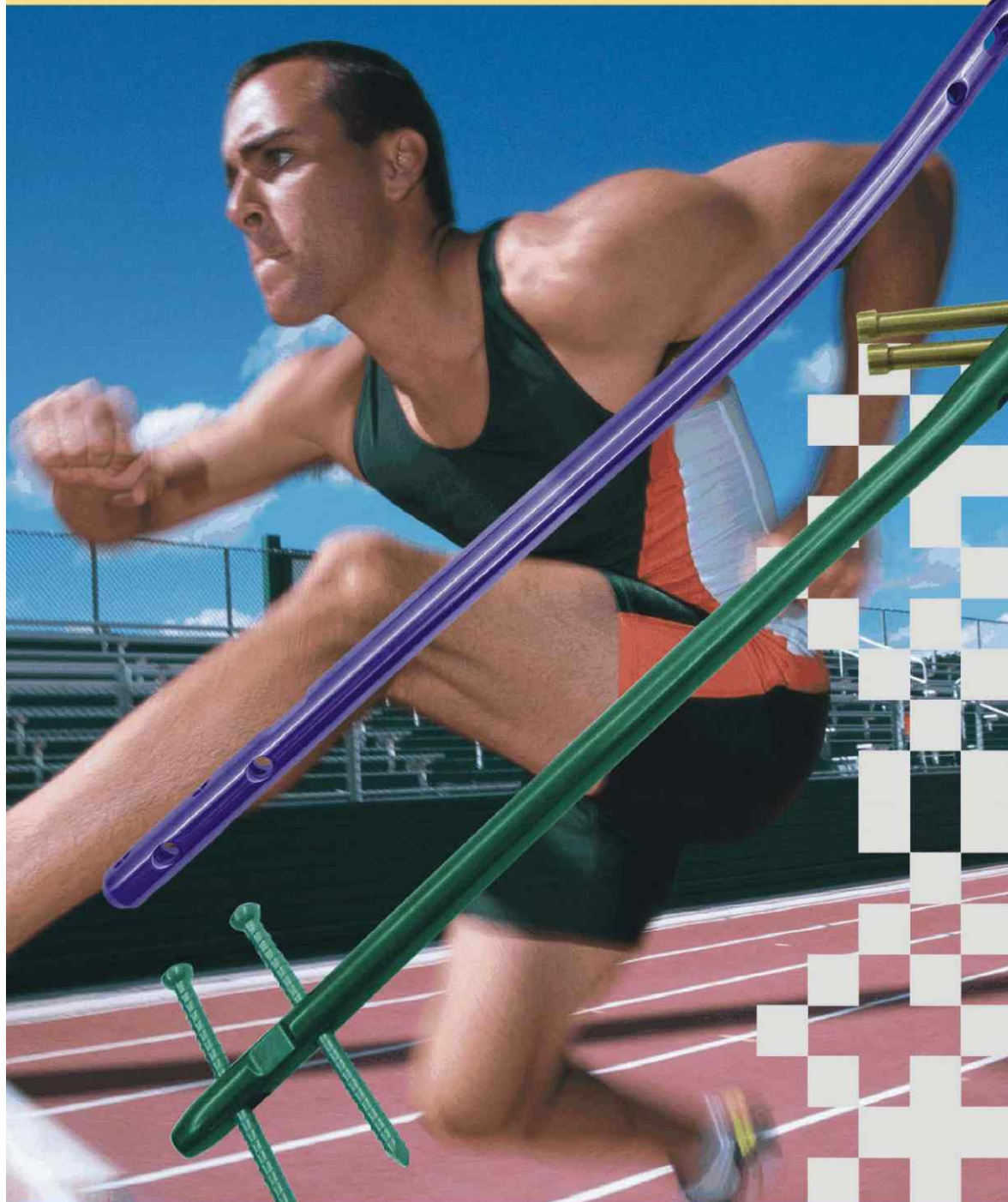

INTERLOCKING NAILS





PERFECT TIBIAL NAILS:

Our Perfect Tibial Nail is indicated for fractures in the Tibial Shaft as well as for Metaphyseal and certain intraarticular fracture of the tibial head and pilon tibiae with :

- Advanced Nail Design : New Anatomic bend for ease of nail insertion. Titanium Alloy for improved mechanical and fatigue properties.
- Advanced Distal Locking Options : Distal Oblique Locking Option to prevent soft tissue damage and increase stability of the distal fragment.
- Versatile Proximal Locking Option : Three unique and innovative locking options, in combination with Cancellous Dual Core locking Screws to increase the stability of the proximal fragment for proximal third fractures.
- Medio Lateral Locking options enable primary compression or secondary controlled dynamization.
- Same Nail for Right & Left Tibia
- Use with Instrument Set - AS075



PERFECT TIBIAL NAIL - CANNULATED

Length in cm.	TITANIUM - Diameter in mm			
	8.4 mm	9 mm	10 mm	11 mm
255	Ti-PT08-255	Ti-PT09-255	Ti-PT10-255	Ti-PT11-255
270	Ti-PT08-270	Ti-PT09-270	Ti-PT10-270	Ti-PT11-270
285	Ti-PT08-285	Ti-PT09-285	Ti-PT10-285	Ti-PT11-285
300	Ti-PT08-300	Ti-PT09-300	Ti-PT10-300	Ti-PT11-300
315	Ti-PT08-315	Ti-PT09-315	Ti-PT10-315	Ti-PT11-315
330	Ti-PT08-330	Ti-PT09-330	Ti-PT10-330	Ti-PT11-330
345	Ti-PT08-345	Ti-PT09-345	Ti-PT10-345	Ti-PT11-345
360	Ti-PT08-360	Ti-PT09-360	Ti-PT10-360	Ti-PT11-360
375	Ti-PT08-375	Ti-PT09-375	Ti-PT10-375	Ti-PT11-375

* Use 4.35mm Locking Screw for Nails Dia. 8mm & 9mm and
 Use 4.8mm Locking Screw for Nails Dia. 10mm & 11mm and
 Use 4.8mm Cancellous Locking Screw (Dual Core) for 3 most Proximal Holes.





**4.8MM CANCELLOUS LOCKING SCREW (DUAL CORE)
FOR PERFECT TIBIAL NAILS**

Length in mm	TITANIUM
25	Ti-PTC5-25
30	Ti-PTC5-30
35	Ti-PTC5-35
40	Ti-PTC5-40
45	Ti-PTC5-45
50	Ti-PTC5-50
55	Ti-PTC5-55
60	Ti-PTC5-60
65	Ti-PTC5-65
70	Ti-PTC5-70
75	Ti-PTC5-75
80	Ti-PTC5-80
85	Ti-PTC5-85
90	Ti-PTC5-90

Drill Bit : 3.2mm



**LOCKING SCREW, 4.35MM
FOR PERFECT TIBIAL NAILS**

Length in mm	TITANIUM
18	Ti-PT4-18
20	Ti-PT4-20
22	Ti-PT4-22
24	Ti-PT4-24
26	Ti-PT4-26
28	Ti-PT4-28
30	Ti-PT4-30
32	Ti-PT4-32
34	Ti-PT4-34
36	Ti-PT4-36
38	Ti-PT4-38
40	Ti-PT4-40
42	Ti-PT4-42
44	Ti-PT4-44
46	Ti-PT4-46
48	Ti-PT4-48
50	Ti-PT4-50
52	Ti-PT4-52
54	Ti-PT4-54
56	Ti-PT4-56
58	Ti-PT4-58
60	Ti-PT4-60
62	Ti-PT4-62
64	Ti-PT4-64
66	Ti-PT4-66
68	Ti-PT4-68
70	Ti-PT4-70
72	Ti-PT4-72
74	Ti-PT4-74
76	Ti-PT4-76
78	Ti-PT4-78
80	Ti-PT4-80

Drill Bit : 4mm



END CAP FOR PERFECT TIBIAL NAILS

Extn. in mm	TITANIUM
0	Ti-PTE.00
5	Ti-PTE.05
10	Ti-PTE.10
15	Ti-PTE.15

Securely locks the most proximal oblique cancellous bone locking screw



END CAP FOR PERFECT TIBIAL NAILS

Extn. in mm	TITANIUM
0	Ti-PTES.00

Securely locks the second proximal oblique cancellous bone locking screw

□ INSTRUMENT SET FOR PERFECT TIBIAL NAILS



LOCKING SCREWS, 4.8MM FOR PERFECT TIBIAL NAILS

Length in mm	TITANIUM
26	Ti-P5-26
28	Ti-P5-28
30	Ti-P5-30
32	Ti-P5-32
34	Ti-P5-34
36	Ti-P5-36
38	Ti-P5-38
40	Ti-P5-40
42	Ti-P5-42
44	Ti-P5-44
46	Ti-P5-46
48	Ti-P5-48
50	Ti-P5-50
52	Ti-P5-52
54	Ti-P5-54
56	Ti-P5-56
58	Ti-P5-58
60	Ti-P5-60
62	Ti-P5-62
64	Ti-P5-64
66	Ti-P5-66
68	Ti-P5-68
70	Ti-P5-70
72	Ti-P5-72
74	Ti-P5-74
76	Ti-P5-76
78	Ti-P5-78
80	Ti-P5-80
85	Ti-P5-85

Drill Bit : 4mm

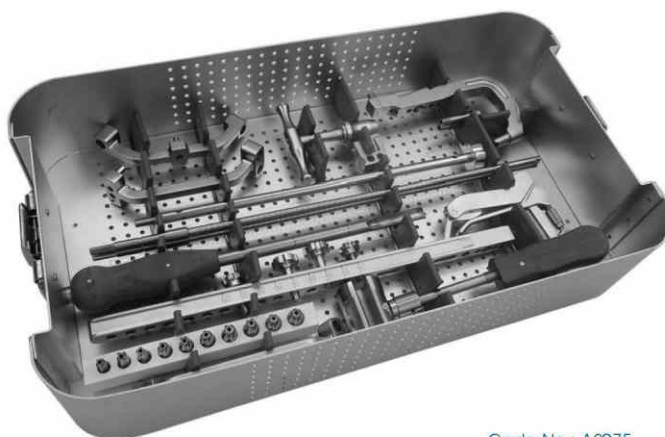
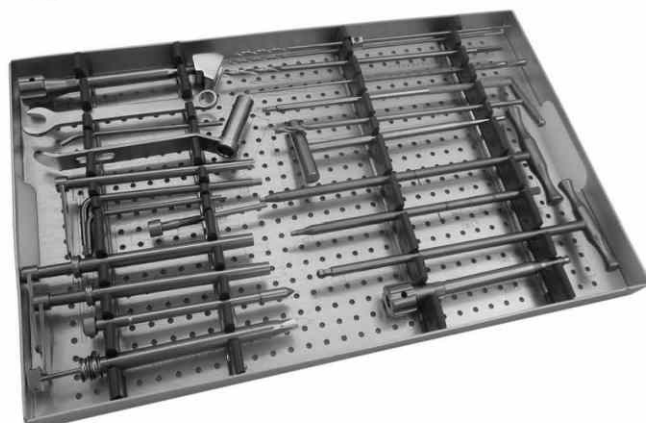
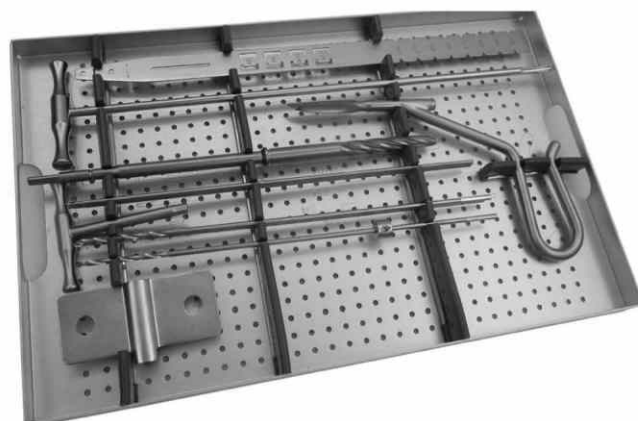

Code No.: AS075

AS075 INSTRUMENTS SET FOR PERFECT TIBIAL NAILS

	<i>Set Consisting of:</i>	Units
501.01	Radiographic Ruler for Perfect Tibial Nail	1
501.02	Protection Sleeve 14x12mm	1
501.03	Cannulated Cutter for Perfect Tibial Nail 12mm	1
501.04	Awl 12mm - cannulated	1
501.05	Drill Bit 12mm - cannulated	1
501.06	Guide Wire 3.2 mm	3
501.07	Insertion Handle for Perfect Tibial Nail	1
501.08	Connecting Screw, cannulated short for Perfect Tibial Nail	2
501.09	Compression Screw for Perfect Tibial Nail	1
501.10	T.Handle for Connecting Screw 6.5mm	1
501.11	Multiaxial T.Handle for Connecting Screw 6.5mm	1
501.12	Connector for Insertion Handle, Length 41mm	2
501.13	Connecting Part for Connector	1
501.14	Hammer Guide Rod	1
501.15	Distal Jig Guide	1
501.16	Distal Alignment Device (T-Type)	1
501.17	Positioning Block for Distal Alignment Device	1
501.18	Distal Aiming Arm	1
501.19	Connecting Part of Distal Aiming Arm	1
501.20	Hexagonal Screw Driver Shaft 3.5 Tip, Long	1
501.21	Proximal Aiming Arm	1
501.22	Proximal Aiming Arm-Angular	1
501.23	Drill Bit 3.2 x 250 Calibrated	2
501.24	Drill Bit 4 x 300	3
501.25	T-Type Drill Bit 5.2mm for Distal Alignment Device	1
501.26	Drill Bit 5.2 x 250 for Distal Alignment Device	1
501.27	Protection Sleeve 8.1 ID x 10 OD	2
501.28	Drill Sleeve 8.0 x 4mm	2
501.29	Drill Sleeve 8.0 x 5.2mm	1
501.30	Protection Sleeve with 3.2 Drill Sleeve & Trocar Pin (Set of 3)	2 set
501.31	Depth Gauge	1
501.32	Hexagonal Screw Driver 3.5mm Tip (Quick Coupling)	1
501.33	Soft Tissue Separator	1
501.34	Reaming Rod 2.5 x 3.9 x 1000 mm	2
501.35	Fracture Alignment Device (T-Type)	1
501.36	L Key 5mm	1
501.37	L Key 3mm	1
501.38	Drill Bit Stopper 4mm	1
501.39	Drill Bit Stopper 3.2mm	1
501.40	Skin Protector (Small)	1
501.41	Locking Bolt (Flower Type) for Proximal Jig - 6mm	2
501.42	Locking Bolt (Flower Type) for Distal Jig - 8mm	2
501.43	Pin Holder	1
501.44	Hexagonal Screw Holder 3.5mm	1
501.45	T-handle -Quick Coupling	1
501.46	Pin Wrench	1
501.47	Combination Wrench 11mm	1
501.48	Sliding Hammer	1
501.49	Nail Extractor	1
501.50	Reamer Shaft	2
501.75	Reamer Head 7.5mm	1
501.80	Reamer Head 8.0mm	1
501.85	Reamer Head 8.5mm	1
501.90	Reamer Head 9.0mm	1
501.95	Reamer Head 9.5mm	1
501.100	Reamer Head 10mm	1
501.105	Reamer Head 10.5mm	1
501.110	Reamer Head 11mm	1
501.115	Reamer Head 11.5mm	1
501.120	Reamer Head 12mm	1
075.000	Empty Container	1



RADIOGRAPHIC RULER

Code No.: 501.01



PROTECTION SLEEVE 14x12MM

Code No.: 501.02



CANNULATED CUTTER

Code No.: 501.03



AWL 12MM - CANNULATED

Code No.: 501.04



CONNECTING SCREW, CANNULATED - SHORT

Code No.: 501.08



COMPRESSION SCREW

Code No.: 501.09



CONNECTOR FOR INSERTION HANDLE, LENGTH 41MM

Code No.: 501.12



DRILL BIT 12MM - CANNULATED

Code No.: 501.05



GUIDE WIRE 3.2 MM

Code No.: 501.06



**MULTIAXIAL T HANDLE
FOR CONNECTING SCREW 6.5MM**
Code No.: 501.11



**DISTAL ALIGNMENT DEVICE
(T-TYPE)**
Code No.: 501.16



**T HANDLE
FOR CONNECTING SCREW 6.5MM**
Code No.: 501.10



INSERTION HANDLE
Code No.: 501.07



**CONNECTING PART
FOR CONNECTOR**
Code No.: 501.13



HEXAGONAL SCREW DRIVER SHAFT 3.5 TIP, LONG
Code No.: 501.20



HAMMER GUIDE ROD
Code No.: 501.14



**CONNECTING PART OF
DISTAL AIMING ARM**
Code No.: 501.19



DISTAL AIMING ARM
Code No.: 501.18



PROXIMAL AIMING ARM
Code No.: 501.21



DISTAL JIG GUIDE
Code No.: 501.15



**POSITIONING BLOCK FOR DISTAL
ALIGNMENT DEVICE**
Code No.: 501.17



**T TYPE DRILL BIT 5.2MM
FOR DISTAL ALIGNMENT DEVICE**
Code No.: 501.25



PROXIMAL AIMING ARM-ANGULAR
Code No.: 501.22



SOFT TISSUE SEPARATOR
Code No.: 501.33



HEXAGONAL SCREW HOLDER 3.5MM
Code No.: 501.44



DRILL BIT 3.2 x 250 CALIBRATED
Code No.: 501.23



DRILL BIT 5.2 x 250 FOR DISTAL ALIGNMENT DEVICE
Code No.: 501.26



DRILL BIT 4MM x 300MM

Code No.: 501.24



**PROTECTION SLEEVE (SET OF 3)
WITH 3.2 DRILL SLEEVE & TROCAR PIN**

Code No.: 501.30



DRILL SLEEVE 8.0 x 4MM

Code No.: 501.28



DRILL SLEEVE 8.0 x 5.2MM

Code No.: 501.29



PROTECTION SLEEVE 8.1ID x 100D

Code No.: 501.27



DEPTH GAUGE

Code No.: 501.31



REAMING ROD 2.5 x 3.9 x 1000MM

Code No.: 501.34



**HEXAGONAL SCREW DRIVER
3.5MM TIP (QUICK COUPLING)**

Code No.: 501.32



SLIDING HAMMER

Code No.: 501.48



FRACTURE ALLIGNMENT DEVICE (T-TYPE)

Code No.: 501.35



L KEY 5MM

Code No.: 501.36



L KEY 3MM

Code No.: 501.37



REAMER SHAFT
Code No.: 501.50



**DRILL BIT STOPPER
4MM**
Code No.: 501.38



**DRILL BIT STOPPER
3.2MM**
Code No.: 501.39



SKIN PROTECTOR (SMALL)
Code No.: 501.40



PIN HOLDER
Code No.: 501.43



**LOCKING BOLT (FLOWER TYPE)
FOR 6MM JIG**
Code No.: 501.41



**LOCKING BOLT (FLOWER TYPE)
FOR 8MM JIG**
Code No.: 501.42



COMBINATION WRENCH 11MM
Code No.: 501.47



REAMER HEAD - 7.5MM TO 12MM
Code No.: 501.75 TO 501.120



T-HANDLE QUICK COUPLING
Code No.: 501.45



PIN WRENCH
Code No.: 501.46



NAIL EXTRACTOR
Code No.: 501.49

DISTAL JIG ASSEMBLY FOR PERFECT TIBIAL NAILS

(To be Ordered Separately)



PROXIMAL LOCKING

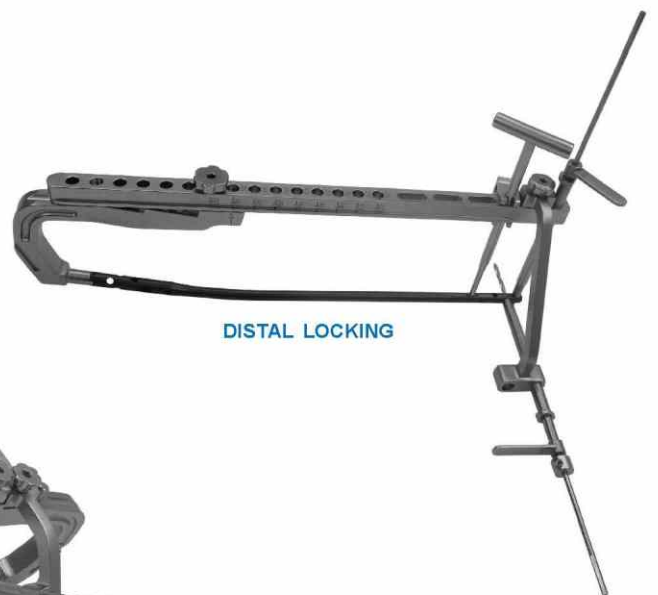

DISTAL LOCKING



PROXIMAL LOCKING

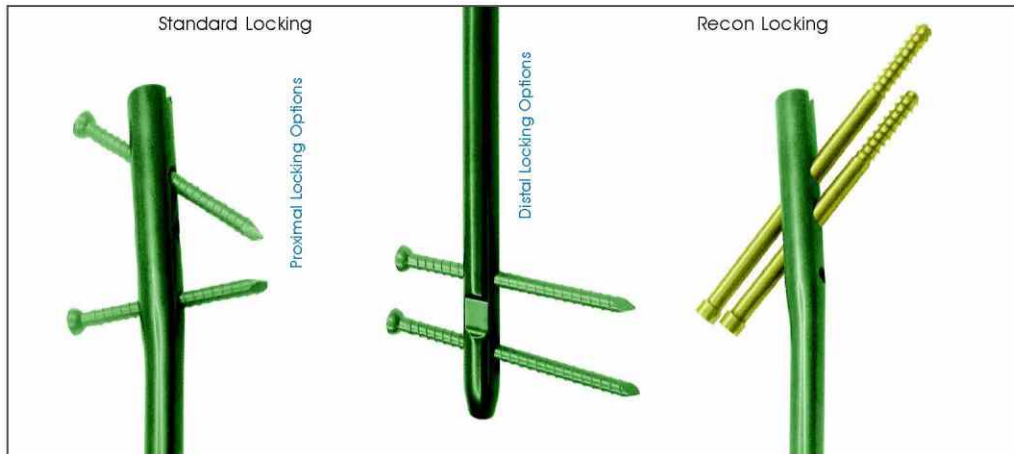

PERFECT FEMORAL NAILS:

Our Perfect Femoral Nail with standard locking is indicated for fractures in femoral shaft and with Recon Locking for fractures in the femoral shaft in combination with femoral neck fractures. Additionally our Perfect Femoral Nail is indicated for fractures in the subtrochanteric section with :

- Advanced Anatomical Nail Design : Optimal fit in bone & easier insertion and extraction. Titanium Alloy for improved mechanical and fatigue properties.
- Optimized Locking Options : Standard Locking of femoral shaft fractures & Recon Locking in subtrochanteric fractures and comined femoral shaft and neck fractures.
- Optimal Lateral entry point : Time saving surgical technique, Easier and safer access to entry site, Less soft tissue damage.
- Improved Locking Options : Higher angular stability through multiplaner screws, less damage of soft tissues and improved mechanical resistance.
- Anatomical Design with Right and Left Nail.
- Use with Instrument Set - AS074

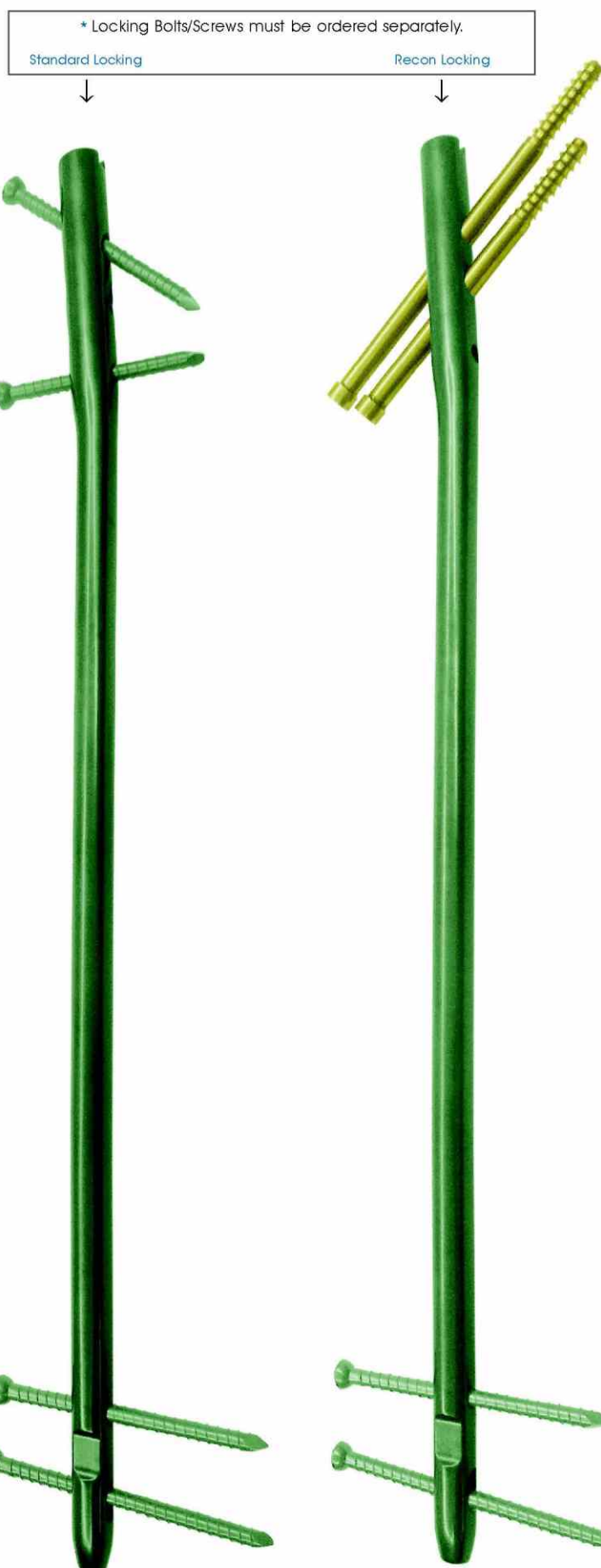

**PERFECT FEMORAL NAIL - CANNULATED (LONG)
FOR LEFT LEG**

Length in mm	TITANIUM - Diameter in mm		
	9 mm	10 mm	11 mm
320	Ti-PF09-32L	Ti-PF10-32L	Ti-PF11-32L
340	Ti-PF09-34L	Ti-PF10-34L	Ti-PF11-34L
360	Ti-PF09-36L	Ti-PF10-36L	Ti-PF11-36L
380	Ti-PF09-38L	Ti-PF10-38L	Ti-PF11-38L
400	Ti-PF09-40L	Ti-PF10-40L	Ti-PF11-40L
420	Ti-PF09-42L	Ti-PF10-42L	Ti-PF11-42L
440	Ti-PF09-44L	Ti-PF10-44L	Ti-PF11-44L

* Use 4.8mm Locking Screw for Standard Locking
Use 6.35mm Hip Screws for Recon Locking

**PERFECT FEMORAL NAIL - CANNULATED (LONG)
FOR RIGHT LEG**

Length in mm	TITANIUM - Diameter in mm		
	9 mm	10 mm	11 mm
320	Ti-PF09-32R	Ti-PF10-32R	Ti-PF11-32R
340	Ti-PF09-34R	Ti-PF10-34R	Ti-PF11-34R
360	Ti-PF09-36R	Ti-PF10-36R	Ti-PF11-36R
380	Ti-PF09-38R	Ti-PF10-38R	Ti-PF11-38R
400	Ti-PF09-40R	Ti-PF10-40R	Ti-PF11-40R
420	Ti-PF09-42R	Ti-PF10-42R	Ti-PF11-42R
440	Ti-PF09-44R	Ti-PF10-44R	Ti-PF11-44R

* Use 4.8mm Locking Screw for Standard Locking
Use 6.35mm Hip Screws for Recon Locking

INTERLOCKING NAILS

...PERFECT FEMORAL NAILS - CANNULATED

* Locking Bolts/Screws must be ordered separately.



PERFECT FEMORAL NAIL - CANNULATED (SHORT)

Length in mm	TITANIUM - Diameter in mm		
	9 mm	10 mm	11 mm
180	Ti-PF09-18	Ti-PF10-18	Ti-PF11-18
200	Ti-PF09-20	Ti-PF10-20	Ti-PF11-20
220	Ti-PF09-22	Ti-PF10-22	Ti-PF11-22
240	Ti-PF09-24	Ti-PF10-24	Ti-PF11-24

* Use 4.8mm Locking Screw for Standard Locking
Use 6.35mm Hip Screws for Recon Locking



HIP SCREWS, 6.35MM FOR RECON LOCKING

Length in mm	TITANIUM
60	Ti-PF65-60
65	Ti-PF65-65
70	Ti-PF65-70
75	Ti-PF65-75
80	Ti-PF65-80
85	Ti-PF65-85
90	Ti-PF65-90
95	Ti-PF65-95
100	Ti-PF65-100
105	Ti-PF65-105
110	Ti-PF65-110
115	Ti-PF65-115

Drill Bit : 5.2mm



END CAP FOR PERFECT FEMORAL NAILS

Extn. in mm	TITANIUM
0	Ti-PFE-00
5	Ti-PFE-05
10	Ti-PFE-10
15	Ti-PFE-15
20	Ti-PFE-20

0mm - sits flush with end of nail
5, 10, 15 and 20 mm extension - extend nail height if nail is over inserted

□ INSTRUMENT SET FOR PERFECT FEMORAL NAILS



LOCKING SCREWS, 4.8MM FOR PERFECT FEMORAL NAILS

Length in mm	TITANIUM
26	Ti-P5-26
28	Ti-P5-28
30	Ti-P5-30
32	Ti-P5-32
34	Ti-P5-34
36	Ti-P5-36
38	Ti-P5-38
40	Ti-P5-40
42	Ti-P5-42
44	Ti-P5-44
46	Ti-P5-46
48	Ti-P5-48
50	Ti-P5-50
52	Ti-P5-52
54	Ti-P5-54
56	Ti-P5-56
58	Ti-P5-58
60	Ti-P5-60
62	Ti-P5-62
64	Ti-P5-64
66	Ti-P5-66
68	Ti-P5-68
70	Ti-P5-70
72	Ti-P5-72
74	Ti-P5-74
76	Ti-P5-76
78	Ti-P5-78
80	Ti-P5-80
85	Ti-P5-85

Drill Bit : 4mm

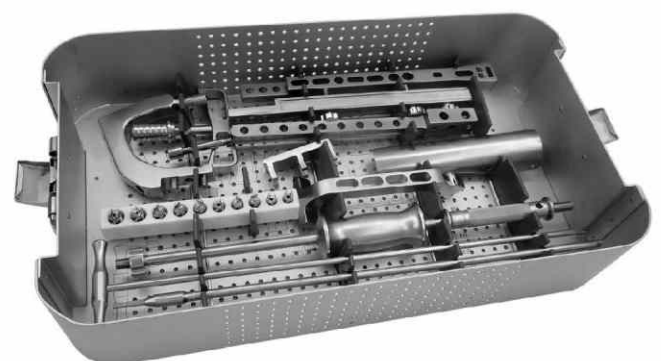
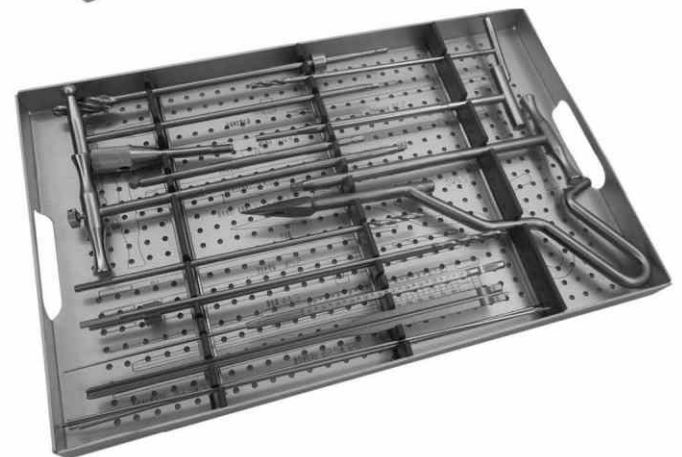
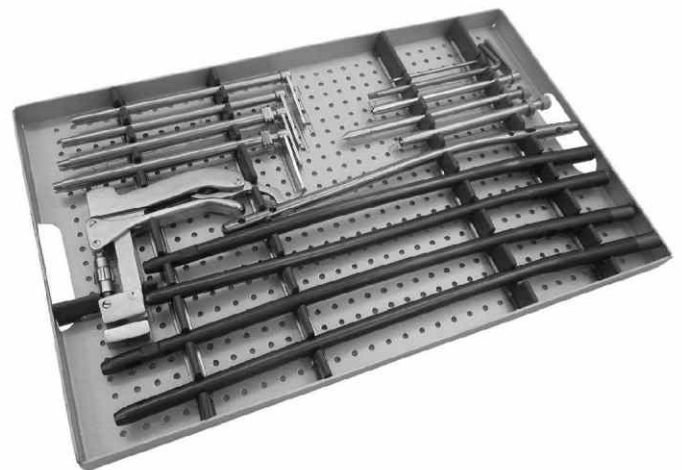

□ INSTRUMENT SET FOR PERFECT FEMORAL NAILS

AS074 INSTRUMENTS SET FOR PERFECT FEMORAL NAILS

<i>Set Consisting of:</i>		Units
500.01	Insertion Handle for Perfect Femoral Nail	1
500.02	Connecting Screw Cannulated for Femoral Nail	1
500.03	Extractor-Impactor	1
500.04	Tissue Protector	1
500.05	Direct Measuring Device	1
500.06	Cannulated Awl	1
500.07	Depth Gauge	1
500.08	Multiaxial (Quick Coupling) T Handle for connecting Screw	1
500.09	Quick Coupling Cannulated Reamer with Stopper 14mm Dia	1
500.10	Guide Pin with Trocar Tip 2.5 x 320mm	2
500.11	Threaded Guide Pin 2.5 x 320mm	2
500.12	T-Type Drill Bit 5.2mm for Distal Alignment Device	1
500.13	Drill Bit 5.2 x 250mm for Distal Alignment Device	1
500.14	Hexagonal Screw Driver T-Type 3.5mm Tip	1
500.15	Protection Sleeve OD10.0 x ID8.0mm (Short)	1
500.16	Protection Sleeve OD10.0 x ID8.0mm (Long)	2
500.17	Drill Sleeve 6.4mm	1
500.18	Guide Wire Sleeve 2.5mm	1
500.19	Drill Sleeve 5.2mm	1
500.20	Drill Sleeve 4mm	2
500.21	Drill Bit Calibrated 4mm	1
500.22	Drill Bit Calibrated 4mm with Stopper	1
500.23	Calibrated Drill Bit 4.5x6.4 with stopper	1
500.24	Cannulated Hexagonal Screw Driver T-Type for 6.35 Screw	1
500.25	Long Coupling Screw for Hexagonal Screw Driver T-Type	1
500.26	Soft Tissue Separator - Short	1
500.27	Soft Tissue Separator - Long	1
500.28	Reaming Rod 2.5x3.9x1000mm	1
500.29	L. Key 3mm	1
500.30	L. Key 5mm	1
500.31	Distal Alignment Device (T-Type)	1
500.32	Positioning Block for Distal Alignment Device	1
500.33	T-Handle for Connecting Screw 6.5mm	1
500.34	Pin Holder	1
500.35	Fracture Alignment Device (T-Type)	1
500.36	Quick Coupling T-Handle	1
500.37	Distal Aiming Arm for Femoral Nail	1
500.38	Proximal Jig Guide	1
500.39	Distal Jig Guide	1
500.40	Proximal Femur Guide for Short Nails	1
500.41	Locking Bolt Flower Type -Small	1
500.42	Locking Bolt Flower Type -Large	2
500.43	Nail Extractor	1
500.44	Flexible Shaft	1
501.85	Reamer Head 8.5mm	1
501.90	Reamer Head 9mm	1
501.95	Reamer Head 9.5mm	1
501.100	Reamer Head 10mm	1
501.105	Reamer Head 10.5mm	1
501.110	Reamer Head 11mm	1
501.115	Reamer Head 11.5mm	1
501.120	Reamer Head 12mm	1
501.125	Reamer Head 12.5mm	1
501.130	Reamer Head 13mm	1
074.000	Empty Container	



TISSUE PROTECTOR
Code No.: 500.04



CONNECTING SCREW - CANNULATED
Code No.: 500.02



PROTECTION SLEEVE OD10.0 x ID8.0MM (SHORT)
Code No.: 500.15



PROTECTION SLEEVE OD10.0 x ID8.0MM (LONG)
Code No.: 500.16



GUIDE WIRE SLEEVE 2.5MM
Code No.: 500.18



DRILL SLEEVE 6.4MM (SHORT)
Code No.: 500.17



DRILL SLEEVE 5.2MM
Code No.: 500.19



DRILL SLEEVE 4MM
Code No.: 500.20



EXTRACTOR-IMPACTOR
Code No.: 500.03



DIRECT MEASURING DEVICE
Code No.: 500.05



MULTIAXIAL (QUICK COUPLING) T HANDLE FOR CONNECTING SCREW
Code No.: 500.08



INSERTION HANDLE
Code No.: 500.01



CANNULATED AWL
Code No.: 500.06



**QUICK COUPLING CANNULATED REAMER
WITH STOPPER 14MM DIA**
Code No.: 500.09



DEPTH GAUGE
Code No.: 500.07



GUIDE PIN WITH TROCAR TIP 2.5x320MM
Code No.: 500.10



THREADED GUIDE PIN 2.5x320MM
Code No.: 500.11



**T-TYPE DRILL BIT 5.2MM
FOR DISTAL ALIGNMENT DEVICE**
Code No.: 500.12



**HEXAGONAL SCREW DRIVER
T-TYPE 3.5MM TIP**
Code No.: 500.14



DRILL BIT 5.2 x 250MM FOR DISTAL ALIGNMENT DEVICE
Code No.: 500.13



DRILL BIT CALIBRATED 4MM
Code No.: 500.21



DRILL BIT CALIBRATED 4MM WITH STOPPER
Code No.: 500.22



CALIBRATED DRILL BIT 4.5x6.4 WITH STOPPER
Code No.: 500.23



**CANNULATED HEXAGONAL SCREW DRIVER T-TYPE
FOR 6.35 SCREW**
Code No.: 500.24



L. KEY 3MM
Code No.: 500.29

L. KEY 5MM
Code No.: 500.30



REAMING ROD 2.5x3.9x1000MM
Code No.: 500.28



LONG COUPLING SCREW FOR HEXAGONAL SCREW DRIVER T-TYPE
Code No.: 500.25



DISTAL ALLIGNMENT DEVICE (T-TYPE)
Code No.: 500.31



T-HANDLE FOR CONNECTING SCREW 6.5MM
Code No.: 500.33



POSITIONING BLOCK FOR DISTAL ALLIGNMENT DEVICE
Code No.: 500.32



DISTAL AIMING ARM
Code No.: 500.37



PIN HOLDER
Code No.: 500.34



SOFT TISSUE SEPARATOR - SHORT
Code No.: 500.26



SOFT TISSUE SEPARATOR - LONG
Code No.: 500.27



QUICK COUPLING T-HANDLE
Code No.: 500.36



REAMER HEAD - 8.5MM TO 13MM
Code No.: 501.85 TO 501.130



FRACTURE ALLIGNMENT DEVICE (T-TYPE)
Code No.: 500.35



PROXIMAL JIG GUIDE
Code No.: 500.38



NAIL EXTRACTOR
Code No.: 500.43



DISTAL JIG GUIDE
Code No.: 500.39



LOCKING BOLT FLOWER TYPE - SMALL
Code No.: 500.41



PROXIMAL FEMUR GUIDE FOR SHORT NAILS
Code No.: 500.40



LOCKING BOLT FLOWER TYPE - LARGE
Code No.: 500.42



FLEXIBLE SHAFT
Code No.: 500.44

DISTAL JIG ASSEMBLY FOR PERFECT FEMORAL NAILS
(To be Ordered Separately)

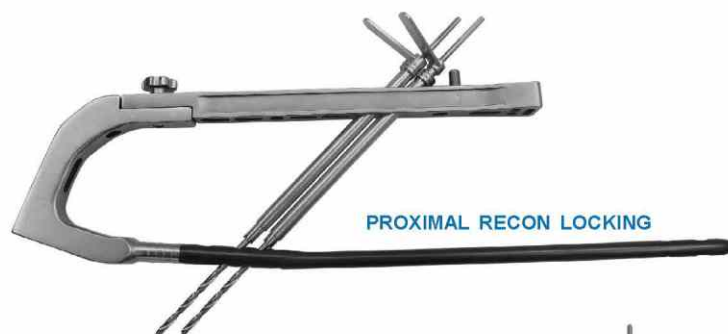

PROXIMAL RECON LOCKING

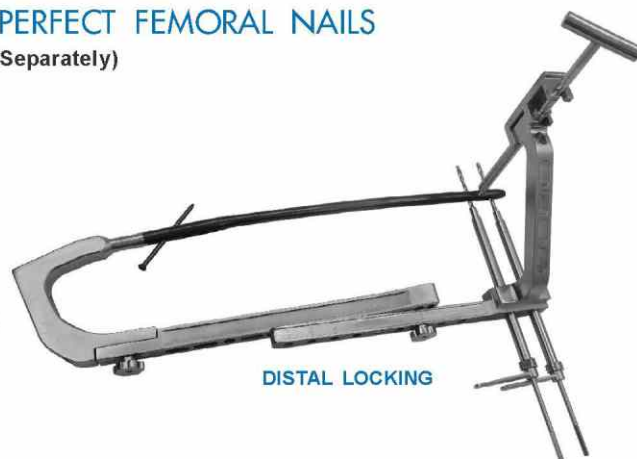

DISTAL LOCKING



PROXIMAL STANDARD LOCKING

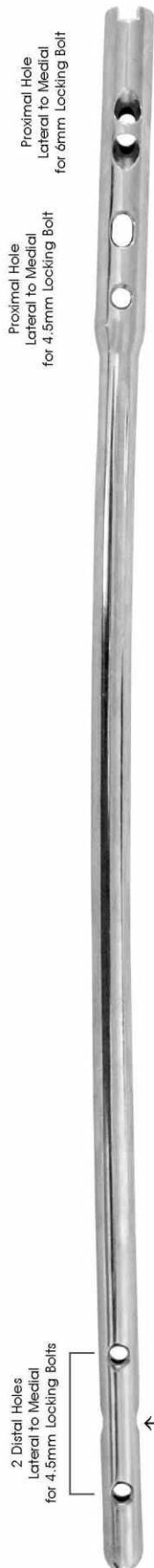

Proximal Dynamic Hole Lateral to Medial for 4.5mm Locking Bolt

MULTI-FIX FEMORAL NAIL - CANNULATED, WITH MULTIPLE LOCKING OPTIONS

Length in cm	STAINLESS STEEL - Diameter in mm					
	9 mm	10 mm	11 mm	12 mm	13 mm	14 mm
32	XPF09-32	XPF10-32	XPF11-32	XPF12-32	XPF13-32	XPF14-32
33	XPF09-33	XPF10-33	XPF11-33	XPF12-33	XPF13-33	XPF14-33
34	XPF09-34	XPF10-34	XPF11-34	XPF12-34	XPF13-34	XPF14-34
35	XPF09-35	XPF10-35	XPF11-35	XPF12-35	XPF13-35	XPF14-35
36	XPF09-36	XPF10-36	XPF11-36	XPF12-36	XPF13-36	XPF14-36
37	XPF09-37	XPF10-37	XPF11-37	XPF12-37	XPF13-37	XPF14-37
38	XPF09-38	XPF10-38	XPF11-38	XPF12-38	XPF13-38	XPF14-38
39	XPF09-39	XPF10-39	XPF11-39	XPF12-39	XPF13-39	XPF14-39
40	XPF09-40	XPF10-40	XPF11-40	XPF12-40	XPF13-40	XPF14-40
41	XPF09-41	XPF10-41	XPF11-41	XPF12-41	XPF13-41	XPF14-41
42	XPF09-42	XPF10-42	XPF11-42	XPF12-42	XPF13-42	XPF14-42
43	XPF09-43	XPF10-43	XPF11-43	XPF12-43	XPF13-43	XPF14-43
44	XPF09-44	XPF10-44	XPF11-44	XPF12-44	XPF13-44	XPF14-44
45	XPF09-45	XPF10-45	XPF11-45	XPF12-45	XPF13-45	XPF14-45
46	XPF09-46	XPF10-46	XPF11-46	XPF12-46	XPF13-46	XPF14-46

MULTI-FIX FEMORAL NAIL - CANNULATED, WITH MULTIPLE LOCKING OPTIONS

Length in cm	TITANIUM - Diameter in mm					
	9 mm	10 mm	11 mm	12 mm	13 mm	14 mm
32	Ti-XPF09-32	Ti-XPF10-32	Ti-XPF11-32	Ti-XPF12-32	Ti-XPF13-32	Ti-XPF14-32
33	Ti-XPF09-33	Ti-XPF10-33	Ti-XPF11-33	Ti-XPF12-33	Ti-XPF13-33	Ti-XPF14-33
34	Ti-XPF09-34	Ti-XPF10-34	Ti-XPF11-34	Ti-XPF12-34	Ti-XPF13-34	Ti-XPF14-34
35	Ti-XPF09-35	Ti-XPF10-35	Ti-XPF11-35	Ti-XPF12-35	Ti-XPF13-35	Ti-XPF14-35
36	Ti-XPF09-36	Ti-XPF10-36	Ti-XPF11-36	Ti-XPF12-36	Ti-XPF13-36	Ti-XPF14-36
37	Ti-XPF09-37	Ti-XPF10-37	Ti-XPF11-37	Ti-XPF12-37	Ti-XPF13-37	Ti-XPF14-37
38	Ti-XPF09-38	Ti-XPF10-38	Ti-XPF11-38	Ti-XPF12-38	Ti-XPF13-38	Ti-XPF14-38
39	Ti-XPF09-39	Ti-XPF10-39	Ti-XPF11-39	Ti-XPF12-39	Ti-XPF13-39	Ti-XPF14-39
40	Ti-XPF09-40	Ti-XPF10-40	Ti-XPF11-40	Ti-XPF12-40	Ti-XPF13-40	Ti-XPF14-40
41	Ti-XPF09-41	Ti-XPF10-41	Ti-XPF11-41	Ti-XPF12-41	Ti-XPF13-41	Ti-XPF14-41
42	Ti-XPF09-42	Ti-XPF10-42	Ti-XPF11-42	Ti-XPF12-42	Ti-XPF13-42	Ti-XPF14-42
43	Ti-XPF09-43	Ti-XPF10-43	Ti-XPF11-43	Ti-XPF12-43	Ti-XPF13-43	Ti-XPF14-43
44	Ti-XPF09-44	Ti-XPF10-44	Ti-XPF11-44	Ti-XPF12-44	Ti-XPF13-44	Ti-XPF14-44
45	Ti-XPF09-45	Ti-XPF10-45	Ti-XPF11-45	Ti-XPF12-45	Ti-XPF13-45	Ti-XPF14-45
46	Ti-XPF09-46	Ti-XPF10-46	Ti-XPF11-46	Ti-XPF12-46	Ti-XPF13-46	Ti-XPF14-46

Same Nail for Right & Left Leg.

Use with Instrument Set - AS071/AS071DJ

Our Multi-fix Tibial & Femoral Nails have dynamic compression hole. Active compression, through intramedullary compression nailing Dynamic Holes, has great utility for treating non-unions where it provides greater degree of impaction of its irregular ends. This may prove greatly advantageous to the fracture union through increased stability and the osteogenic potential, particularly when utilized in combination with the small diameter unreamed nails.

YouTube www.TV.ortho.in/12603

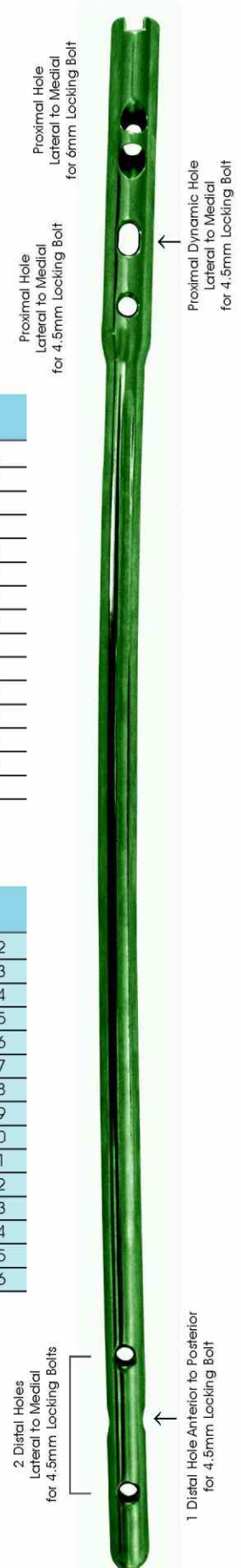

Proximal Dynamic Hole Lateral to Medial for 4.5mm Locking Bolt

2 Distal Holes Lateral to Medial for 4.5mm Locking Bolts

1 Distal Hole Anterior to Posterior for 4.5mm Locking Bolt

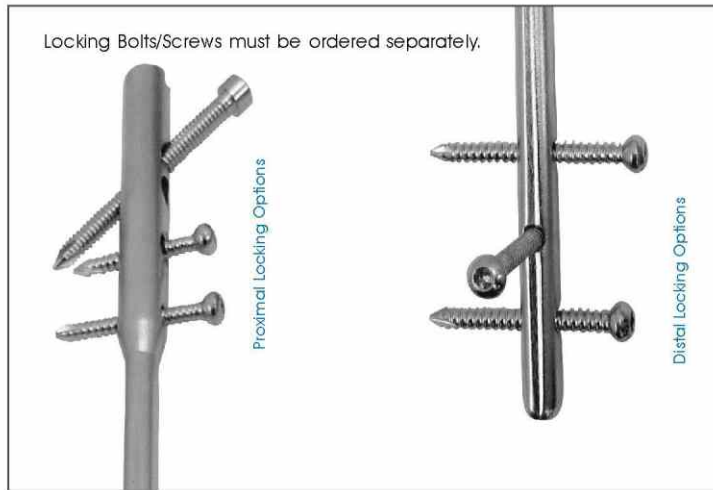

MULTI-FIX FEMORAL NAIL - UNREAMED WITH MULTIPLE LOCKING OPTIONS

Length in cm	S.S. - Diameter in mm	
	9 mm	10 mm
32	XPUFN09-32U	XPUFN10-32U
33	XPUFN09-33U	XPUFN10-33U
34	XPUFN09-34U	XPUFN10-34U
35	XPUFN09-35U	XPUFN10-35U
36	XPUFN09-36U	XPUFN10-36U
37	XPUFN09-37U	XPUFN10-37U
38	XPUFN09-38U	XPUFN10-38U
39	XPUFN09-39U	XPUFN10-39U
40	XPUFN09-40U	XPUFN10-40U
41	XPUFN09-41U	XPUFN10-41U
42	XPUFN09-42U	XPUFN10-42U
43	XPUFN09-43U	XPUFN10-43U
44	XPUFN09-44U	XPUFN10-44U
45	XPUFN09-45U	XPUFN10-45U
46	XPUFN09-46U	XPUFN10-46U

Length in cm	TITANIUM - Diameter in mm	
	9 mm	10 mm
32	Ti-XPUFN09-32U	Ti-XPUFN10-32U
33	Ti-XPUFN09-33U	Ti-XPUFN10-33U
34	Ti-XPUFN09-34U	Ti-XPUFN10-34U
35	Ti-XPUFN09-35U	Ti-XPUFN10-35U
36	Ti-XPUFN09-36U	Ti-XPUFN10-36U
37	Ti-XPUFN09-37U	Ti-XPUFN10-37U
38	Ti-XPUFN09-38U	Ti-XPUFN10-38U
39	Ti-XPUFN09-39U	Ti-XPUFN10-39U
40	Ti-XPUFN09-40U	Ti-XPUFN10-40U
41	Ti-XPUFN09-41U	Ti-XPUFN10-41U
42	Ti-XPUFN09-42U	Ti-XPUFN10-42U
43	Ti-XPUFN09-43U	Ti-XPUFN10-43U
44	Ti-XPUFN09-44U	Ti-XPUFN10-44U
45	Ti-XPUFN09-45U	Ti-XPUFN10-45U
46	Ti-XPUFN09-46U	Ti-XPUFN10-46U

Same Nail for Right & Left Leg.

Use with Instrument Set - AS071/AS071DJ

Our Multi-fix Tibial & Femoral Nails have dynamic compression hole. Active compression, through intramedullary compression nailing Dynamic Holes, has great utility for treating non-unions where it provides greater degree of impaction of its irregular ends. This may prove greatly advantageous to the fracture union through increased stability and the osteogenic potential, particularly when utilized in combination with the small diameter unreamed nails.

www.TV.ortho.in/171



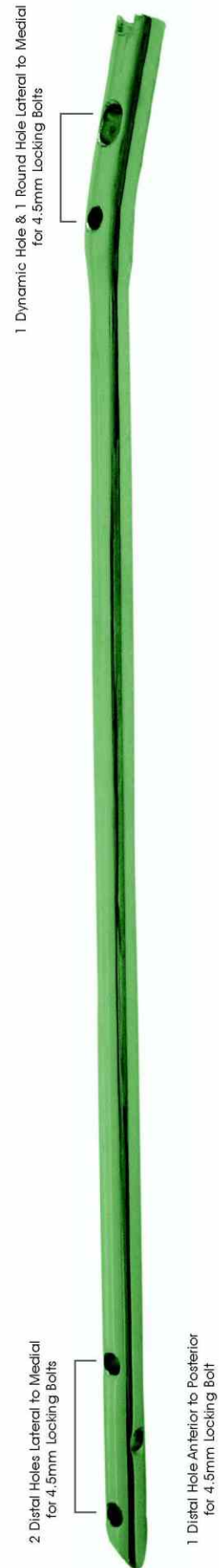

MULTI-FIX TIBIAL NAIL - UNREAMED (DYNAMIC HOLE)

Length in cm	S.S. - Diameter in mm	
	8 mm	9 mm
26	MLUTN08-26	MLUTN09-26
27	MLUTN08-27	MLUTN09-27
28	MLUTN08-28	MLUTN09-28
29	MLUTN08-29	MLUTN09-29
30	MLUTN08-30	MLUTN09-30
31	MLUTN08-31	MLUTN09-31
32	MLUTN08-32	MLUTN09-32
33	MLUTN08-33	MLUTN09-33
34	MLUTN08-34	MLUTN09-34
35	MLUTN08-35	MLUTN09-35
36	MLUTN08-36	MLUTN09-36
37	MLUTN08-37	MLUTN09-37
38	MLUTN08-38	MLUTN09-38
39	MLUTN08-39	MLUTN09-39
40	MLUTN08-40	MLUTN09-40
41	MLUTN08-41	MLUTN09-41
42	MLUTN08-42	MLUTN09-42
43	MLUTN08-43	MLUTN09-43
44	MLUTN08-44	MLUTN09-44

Length in cm	TITANIUM - Diameter in mm	
	8 mm	9 mm
26	Ti-MLUTN08-26	Ti-MLUTN09-26
27	Ti-MLUTN08-27	Ti-MLUTN09-27
28	Ti-MLUTN08-28	Ti-MLUTN09-28
29	Ti-MLUTN08-29	Ti-MLUTN09-29
30	Ti-MLUTN08-30	Ti-MLUTN09-30
31	Ti-MLUTN08-31	Ti-MLUTN09-31
32	Ti-MLUTN08-32	Ti-MLUTN09-32
33	Ti-MLUTN08-33	Ti-MLUTN09-33
34	Ti-MLUTN08-34	Ti-MLUTN09-34
35	Ti-MLUTN08-35	Ti-MLUTN09-35
36	Ti-MLUTN08-36	Ti-MLUTN09-36
37	Ti-MLUTN08-37	Ti-MLUTN09-37
38	Ti-MLUTN08-38	Ti-MLUTN09-38
39	Ti-MLUTN08-39	Ti-MLUTN09-39
40	Ti-MLUTN08-40	Ti-MLUTN09-40
41	Ti-MLUTN08-41	Ti-MLUTN09-41
42	Ti-MLUTN08-42	Ti-MLUTN09-42
43	Ti-MLUTN08-43	Ti-MLUTN09-43
44	Ti-MLUTN08-44	Ti-MLUTN09-44

Same Nail for Right & Left Leg.

Use with Instrument Set - AS071/AS071DJ

Our Multi-fix Tibial & Femoral Nails have dynamic compression hole. Active compression, through intramedullary compression nailing Dynamic Holes, has great utility for treating non-unions where it provides greater degree of impaction of its irregular ends. This may prove greatly advantageous to the fracture union through increased stability and the osteogenic potential, particularly when utilized in combination with the small diameter unreamed nails.

MULTI-FIX TIBIAL NAIL - CANNULATED (DYNAMIC HOLE)

Length in cm	STAINLESS STEEL - Diameter in mm					
	9 mm	10 mm	11 mm	12 mm	13 mm	14 mm
26	MLT09-26	MLT10-26	MLT11-26	MLT12-26	MLT13-26	MLT14-26
27	MLT09-27	MLT10-27	MLT11-27	MLT12-27	MLT13-27	MLT14-27
28	MLT09-28	MLT10-28	MLT11-28	MLT12-28	MLT13-28	MLT14-28
29	MLT09-29	MLT10-29	MLT11-29	MLT12-29	MLT13-29	MLT14-29
30	MLT09-30	MLT10-30	MLT11-30	MLT12-30	MLT13-30	MLT14-30
31	MLT09-31	MLT10-31	MLT11-31	MLT12-31	MLT13-31	MLT14-31
32	MLT09-32	MLT10-32	MLT11-32	MLT12-32	MLT13-32	MLT14-32
33	MLT09-33	MLT10-33	MLT11-33	MLT12-33	MLT13-33	MLT14-33
34	MLT09-34	MLT10-34	MLT11-34	MLT12-34	MLT13-34	MLT14-34
35	MLT09-35	MLT10-35	MLT11-35	MLT12-35	MLT13-35	MLT14-35
36	MLT09-36	MLT10-36	MLT11-36	MLT12-36	MLT13-36	MLT14-36
37	MLT09-37	MLT10-37	MLT11-37	MLT12-37	MLT13-37	MLT14-37
38	MLT09-38	MLT10-38	MLT11-38	MLT12-38	MLT13-38	MLT14-38
39	MLT09-39	MLT10-39	MLT11-39	MLT12-39	MLT13-39	MLT14-39
40	MLT09-40	MLT10-40	MLT11-40	MLT12-40	MLT13-40	MLT14-40
41	MLT09-41	MLT10-41	MLT11-41	MLT12-41	MLT13-41	MLT14-41
42	MLT09-42	MLT10-42	MLT11-42	MLT12-42	MLT13-42	MLT14-42
43	MLT09-43	MLT10-43	MLT11-43	MLT12-43	MLT13-43	MLT14-43
44	MLT09-44	MLT10-44	MLT11-44	MLT12-44	MLT13-44	MLT14-44

MULTI-FIX TIBIAL NAIL - CANNULATED (DYNAMIC HOLE)

Length in cm	TITANIUM - Diameter in mm					
	9 mm	10 mm	11 mm	12 mm	13 mm	14 mm
26	Ti-MLT09-26	Ti-MLT10-26	Ti-MLT11-26	Ti-MLT12-26	Ti-MLT13-26	Ti-MLT14-26
27	Ti-MLT09-27	Ti-MLT10-27	Ti-MLT11-27	Ti-MLT12-27	Ti-MLT13-27	Ti-MLT14-27
28	Ti-MLT09-28	Ti-MLT10-28	Ti-MLT11-28	Ti-MLT12-28	Ti-MLT13-28	Ti-MLT14-28
29	Ti-MLT09-29	Ti-MLT10-29	Ti-MLT11-29	Ti-MLT12-29	Ti-MLT13-29	Ti-MLT14-29
30	Ti-MLT09-30	Ti-MLT10-30	Ti-MLT11-30	Ti-MLT12-30	Ti-MLT13-30	Ti-MLT14-30
31	Ti-MLT09-31	Ti-MLT10-31	Ti-MLT11-31	Ti-MLT12-31	Ti-MLT13-31	Ti-MLT14-31
32	Ti-MLT09-32	Ti-MLT10-32	Ti-MLT11-32	Ti-MLT12-32	Ti-MLT13-32	Ti-MLT14-32
33	Ti-MLT09-33	Ti-MLT10-33	Ti-MLT11-33	Ti-MLT12-33	Ti-MLT13-33	Ti-MLT14-33
34	Ti-MLT09-34	Ti-MLT10-34	Ti-MLT11-34	Ti-MLT12-34	Ti-MLT13-34	Ti-MLT14-34
35	Ti-MLT09-35	Ti-MLT10-35	Ti-MLT11-35	Ti-MLT12-35	Ti-MLT13-35	Ti-MLT14-35
36	Ti-MLT09-36	Ti-MLT10-36	Ti-MLT11-36	Ti-MLT12-36	Ti-MLT13-36	Ti-MLT14-36
37	Ti-MLT09-37	Ti-MLT10-37	Ti-MLT11-37	Ti-MLT12-37	Ti-MLT13-37	Ti-MLT14-37
38	Ti-MLT09-38	Ti-MLT10-38	Ti-MLT11-38	Ti-MLT12-38	Ti-MLT13-38	Ti-MLT14-38
39	Ti-MLT09-39	Ti-MLT10-39	Ti-MLT11-39	Ti-MLT12-39	Ti-MLT13-39	Ti-MLT14-39
40	Ti-MLT09-40	Ti-MLT10-40	Ti-MLT11-40	Ti-MLT12-40	Ti-MLT13-40	Ti-MLT14-40
41	Ti-MLT09-41	Ti-MLT10-41	Ti-MLT11-41	Ti-MLT12-41	Ti-MLT13-41	Ti-MLT14-41
42	Ti-MLT09-42	Ti-MLT10-42	Ti-MLT11-42	Ti-MLT12-42	Ti-MLT13-42	Ti-MLT14-42
43	Ti-MLT09-43	Ti-MLT10-43	Ti-MLT11-43	Ti-MLT12-43	Ti-MLT13-43	Ti-MLT14-43
44	Ti-MLT09-44	Ti-MLT10-44	Ti-MLT11-44	Ti-MLT12-44	Ti-MLT13-44	Ti-MLT14-44

Same Nail for Right & Left Leg.

Use with Instrument Set - AS071/AS071DJ

Our Multi-fix Tibial & Femoral Nails have dynamic compression hole. Active compression, through intramedullary compression nailing Dynamic Holes, has great utility for treating non-unions where it provides greater degree of impaction of its irregular ends. This may prove greatly advantageous to the fracture union through increased stability and the osteogenic potential, particularly when utilized in combination with the small diameter unreamed nails.





Proximal Hole Lateral to Medial for 6mm Locking Bolt



Proximal Hole Lateral to Medial for 6mm Locking Bolt

XL FEMORAL NAIL - CANNULATED

Length in cm	STAINLESS STEEL - Diameter in mm					
	9 mm	10 mm	11 mm	12 mm	13 mm	14 mm
32	XLF09-32U	XLF10-32U	XLF11-32U	XLF12-32U	XLF13-32U	XLF14-32U
33	XLF09-33U	XLF10-33U	XLF11-33U	XLF12-33U	XLF13-33U	XLF14-33U
34	XLF09-34U	XLF10-34U	XLF11-34U	XLF12-34U	XLF13-34U	XLF14-34U
35	XLF09-35U	XLF10-35U	XLF11-35U	XLF12-35U	XLF13-35U	XLF14-35U
36	XLF09-36U	XLF10-36U	XLF11-36U	XLF12-36U	XLF13-36U	XLF14-36U
37	XLF09-37U	XLF10-37U	XLF11-37U	XLF12-37U	XLF13-37U	XLF14-37U
38	XLF09-38U	XLF10-38U	XLF11-38U	XLF12-38U	XLF13-38U	XLF14-38U
39	XLF09-39U	XLF10-39U	XLF11-39U	XLF12-39U	XLF13-39U	XLF14-39U
40	XLF09-40U	XLF10-40U	XLF11-40U	XLF12-40U	XLF13-40U	XLF14-40U
41	XLF09-41U	XLF10-41U	XLF11-41U	XLF12-41U	XLF13-41U	XLF14-41U
42	XLF09-42U	XLF10-42U	XLF11-42U	XLF12-42U	XLF13-42U	XLF14-42U
43	XLF09-43U	XLF10-43U	XLF11-43U	XLF12-43U	XLF13-43U	XLF14-43U
44	XLF09-44U	XLF10-44U	XLF11-44U	XLF12-44U	XLF13-44U	XLF14-44U
45	XLF09-45U	XLF10-45U	XLF11-45U	XLF12-45U	XLF13-45U	XLF14-45U
46	XLF09-46U	XLF10-46U	XLF11-46U	XLF12-46U	XLF13-46U	XLF14-46U

Same Nail for Right & Left Leg.

Use with Instrument Set - AS071/AS071DJ

XL FEMORAL NAIL - CANNULATED

Length in cm	TITANIUM - Diameter in mm					
	9 mm	10 mm	11 mm	12 mm	13 mm	14 mm
32	Ti-XLF09-32U	Ti-XLF10-32U	Ti-XLF11-32U	Ti-XLF12-32U	Ti-XLF13-32U	Ti-XLF14-32U
33	Ti-XLF09-33U	Ti-XLF10-33U	Ti-XLF11-33U	Ti-XLF12-33U	Ti-XLF13-33U	Ti-XLF14-33U
34	Ti-XLF09-34U	Ti-XLF10-34U	Ti-XLF11-34U	Ti-XLF12-34U	Ti-XLF13-34U	Ti-XLF14-34U
35	Ti-XLF09-35U	Ti-XLF10-35U	Ti-XLF11-35U	Ti-XLF12-35U	Ti-XLF13-35U	Ti-XLF14-35U
36	Ti-XLF09-36U	Ti-XLF10-36U	Ti-XLF11-36U	Ti-XLF12-36U	Ti-XLF13-36U	Ti-XLF14-36U
37	Ti-XLF09-37U	Ti-XLF10-37U	Ti-XLF11-37U	Ti-XLF12-37U	Ti-XLF13-37U	Ti-XLF14-37U
38	Ti-XLF09-38U	Ti-XLF10-38U	Ti-XLF11-38U	Ti-XLF12-38U	Ti-XLF13-38U	Ti-XLF14-38U
39	Ti-XLF09-39U	Ti-XLF10-39U	Ti-XLF11-39U	Ti-XLF12-39U	Ti-XLF13-39U	Ti-XLF14-39U
40	Ti-XLF09-40U	Ti-XLF10-40U	Ti-XLF11-40U	Ti-XLF12-40U	Ti-XLF13-40U	Ti-XLF14-40U
41	Ti-XLF09-41U	Ti-XLF10-41U	Ti-XLF11-41U	Ti-XLF12-41U	Ti-XLF13-41U	Ti-XLF14-41U
42	Ti-XLF09-42U	Ti-XLF10-42U	Ti-XLF11-42U	Ti-XLF12-42U	Ti-XLF13-42U	Ti-XLF14-42U
43	Ti-XLF09-43U	Ti-XLF10-43U	Ti-XLF11-43U	Ti-XLF12-43U	Ti-XLF13-43U	Ti-XLF14-43U
44	Ti-XLF09-44U	Ti-XLF10-44U	Ti-XLF11-44U	Ti-XLF12-44U	Ti-XLF13-44U	Ti-XLF14-44U
45	Ti-XLF09-45U	Ti-XLF10-45U	Ti-XLF11-45U	Ti-XLF12-45U	Ti-XLF13-45U	Ti-XLF14-45U
46	Ti-XLF09-46U	Ti-XLF10-46U	Ti-XLF11-46U	Ti-XLF12-46U	Ti-XLF13-46U	Ti-XLF14-46U

Same Nail for Right & Left Leg.

Use with Instrument Set - AS071/AS071DJ

2 Distal Holes Lateral to Medial for 4.5mm Locking Bolts

2 Distal Holes Lateral to Medial for 4.5mm Locking Bolts



2 Distal Holes Lateral to Medial for 4.5mm Locking Bolts

Proximal Hole Lateral to Medial for 6mm Locking Bolt

XL FEMORAL NAIL - UNREAMED

Length in cm	S.S. - Diameter in mm	
	9 mm	10 mm
32	XLUFN09-32U	XLUFN10-32U
33	XLUFN09-33U	XLUFN10-33U
34	XLUFN09-34U	XLUFN10-34U
35	XLUFN09-35U	XLUFN10-35U
36	XLUFN09-36U	XLUFN10-36U
37	XLUFN09-37U	XLUFN10-37U
38	XLUFN09-38U	XLUFN10-38U
39	XLUFN09-39U	XLUFN10-39U
40	XLUFN09-40U	XLUFN10-40U
41	XLUFN09-41U	XLUFN10-41U
42	XLUFN09-42U	XLUFN10-42U
43	XLUFN09-43U	XLUFN10-43U
44	XLUFN09-44U	XLUFN10-44U

Same Nail for Right & Left Leg.
Use with Instrument Set - AS071/AS071DJ

Length in cm	TITANIUM - Diameter in mm	
	9 mm	10 mm
32	Ti-XLUFN09-32U	Ti-XLUFN10-32U
33	Ti-XLUFN09-33U	Ti-XLUFN10-33U
34	Ti-XLUFN09-34U	Ti-XLUFN10-34U
35	Ti-XLUFN09-35U	Ti-XLUFN10-35U
36	Ti-XLUFN09-36U	Ti-XLUFN10-36U
37	Ti-XLUFN09-37U	Ti-XLUFN10-37U
38	Ti-XLUFN09-38U	Ti-XLUFN10-38U
39	Ti-XLUFN09-39U	Ti-XLUFN10-39U
40	Ti-XLUFN09-40U	Ti-XLUFN10-40U
41	Ti-XLUFN09-41U	Ti-XLUFN10-41U
42	Ti-XLUFN09-42U	Ti-XLUFN10-42U
43	Ti-XLUFN09-43U	Ti-XLUFN10-43U
44	Ti-XLUFN09-44U	Ti-XLUFN10-44U



2 Distal Holes Lateral to Medial for 4.5mm Locking Bolts

Proximal Hole Lateral to Medial for 6mm Locking Bolt



 www.TV.ortho.in/147

XL TIBIAL NAIL - CANNULATED (STANDARD HOLE)

Length in cm	STAINLESS STEEL - Diameter in mm					
	9 mm	10 mm	11 mm	12 mm	13 mm	14 mm
26	XLT09-26	XLT10-26	XLT11-26	XLT12-26	XLT13-26	XLT14-26
27	XLT09-27	XLT10-27	XLT11-27	XLT12-27	XLT13-27	XLT14-27
28	XLT09-28	XLT10-28	XLT11-28	XLT12-28	XLT13-28	XLT14-28
29	XLT09-29	XLT10-29	XLT11-29	XLT12-29	XLT13-29	XLT14-29
30	XLT09-30	XLT10-30	XLT11-30	XLT12-30	XLT13-30	XLT14-30
31	XLT09-31	XLT10-31	XLT11-31	XLT12-31	XLT13-31	XLT14-31
32	XLT09-32	XLT10-32	XLT11-32	XLT12-32	XLT13-32	XLT14-32
33	XLT09-33	XLT10-33	XLT11-33	XLT12-33	XLT13-33	XLT14-33
34	XLT09-34	XLT10-34	XLT11-34	XLT12-34	XLT13-34	XLT14-34
35	XLT09-35	XLT10-35	XLT11-35	XLT12-35	XLT13-35	XLT14-35
36	XLT09-36	XLT10-36	XLT11-36	XLT12-36	XLT13-36	XLT14-36
37	XLT09-37	XLT10-37	XLT11-37	XLT12-37	XLT13-37	XLT14-37
38	XLT09-38	XLT10-38	XLT11-38	XLT12-38	XLT13-38	XLT14-38
39	XLT09-39	XLT10-39	XLT11-39	XLT12-39	XLT13-39	XLT14-39
40	XLT09-40	XLT10-40	XLT11-40	XLT12-40	XLT13-40	XLT14-40
41	XLT09-41	XLT10-41	XLT11-41	XLT12-41	XLT13-41	XLT14-41
42	XLT09-42	XLT10-42	XLT11-42	XLT12-42	XLT13-42	XLT14-42
43	XLT09-43	XLT10-43	XLT11-43	XLT12-43	XLT13-43	XLT14-43
44	XLT09-44	XLT10-44	XLT11-44	XLT12-44	XLT13-44	XLT14-44

Same Nail for Right & Left Leg.

Use with Instrument Set - AS071/AS071DJ

XL TIBIAL NAIL - CANNULATED (STANDARD HOLE)

Length in cm	TITANIUM - Diameter in mm					
	9 mm	10 mm	11 mm	12 mm	13 mm	14 mm
26	Ti-XLT09-26	Ti-XLT10-26	Ti-XLT11-26	Ti-XLT12-26	Ti-XLT13-26	Ti-XLT14-26
27	Ti-XLT09-27	Ti-XLT10-27	Ti-XLT11-27	Ti-XLT12-27	Ti-XLT13-27	Ti-XLT14-27
28	Ti-XLT09-28	Ti-XLT10-28	Ti-XLT11-28	Ti-XLT12-28	Ti-XLT13-28	Ti-XLT14-28
29	Ti-XLT09-29	Ti-XLT10-29	Ti-XLT11-29	Ti-XLT12-29	Ti-XLT13-29	Ti-XLT14-29
30	Ti-XLT09-30	Ti-XLT10-30	Ti-XLT11-30	Ti-XLT12-30	Ti-XLT13-30	Ti-XLT14-30
31	Ti-XLT09-31	Ti-XLT10-31	Ti-XLT11-31	Ti-XLT12-31	Ti-XLT13-31	Ti-XLT14-31
32	Ti-XLT09-32	Ti-XLT10-32	Ti-XLT11-32	Ti-XLT12-32	Ti-XLT13-32	Ti-XLT14-32
33	Ti-XLT09-33	Ti-XLT10-33	Ti-XLT11-33	Ti-XLT12-33	Ti-XLT13-33	Ti-XLT14-33
34	Ti-XLT09-34	Ti-XLT10-34	Ti-XLT11-34	Ti-XLT12-34	Ti-XLT13-34	Ti-XLT14-34
35	Ti-XLT09-35	Ti-XLT10-35	Ti-XLT11-35	Ti-XLT12-35	Ti-XLT13-35	Ti-XLT14-35
36	Ti-XLT09-36	Ti-XLT10-36	Ti-XLT11-36	Ti-XLT12-36	Ti-XLT13-36	Ti-XLT14-36
37	Ti-XLT09-37	Ti-XLT10-37	Ti-XLT11-37	Ti-XLT12-37	Ti-XLT13-37	Ti-XLT14-37
38	Ti-XLT09-38	Ti-XLT10-38	Ti-XLT11-38	Ti-XLT12-38	Ti-XLT13-38	Ti-XLT14-38
39	Ti-XLT09-39	Ti-XLT10-39	Ti-XLT11-39	Ti-XLT12-39	Ti-XLT13-39	Ti-XLT14-39
40	Ti-XLT09-40	Ti-XLT10-40	Ti-XLT11-40	Ti-XLT12-40	Ti-XLT13-40	Ti-XLT14-40
41	Ti-XLT09-41	Ti-XLT10-41	Ti-XLT11-41	Ti-XLT12-41	Ti-XLT13-41	Ti-XLT14-41
42	Ti-XLT09-42	Ti-XLT10-42	Ti-XLT11-42	Ti-XLT12-42	Ti-XLT13-42	Ti-XLT14-42
43	Ti-XLT09-43	Ti-XLT10-43	Ti-XLT11-43	Ti-XLT12-43	Ti-XLT13-43	Ti-XLT14-43
44	Ti-XLT09-44	Ti-XLT10-44	Ti-XLT11-44	Ti-XLT12-44	Ti-XLT13-44	Ti-XLT14-44

Same Nail for Right & Left Leg.

Use with Instrument Set - AS071/AS071DJ





YouTube www.TV.ortho.in/146

XL TIBIAL NAIL - CANNULATED (DYNAMIC HOLE)

Length in cm	STAINLESS STEEL - Diameter in mm					
	9 mm	10 mm	11 mm	12 mm	13 mm	14 mm
26	XLT09-26D	XLT10-26D	XLT11-26D	XLT12-26D	XLT13-26D	XLT14-26D
27	XLT09-27D	XLT10-27D	XLT11-27D	XLT12-27D	XLT13-27D	XLT14-27D
28	XLT09-28D	XLT10-28D	XLT11-28D	XLT12-28D	XLT13-28D	XLT14-28D
29	XLT09-29D	XLT10-29D	XLT11-29D	XLT12-29D	XLT13-29D	XLT14-29D
30	XLT09-30D	XLT10-30D	XLT11-30D	XLT12-30D	XLT13-30D	XLT14-30D
31	XLT09-31D	XLT10-31D	XLT11-31D	XLT12-31D	XLT13-31D	XLT14-31D
32	XLT09-32D	XLT10-32D	XLT11-32D	XLT12-32D	XLT13-32D	XLT14-32D
33	XLT09-33D	XLT10-33D	XLT11-33D	XLT12-33D	XLT13-33D	XLT14-33D
34	XLT09-34D	XLT10-34D	XLT11-34D	XLT12-34D	XLT13-34D	XLT14-34D
35	XLT09-35D	XLT10-35D	XLT11-35D	XLT12-35D	XLT13-35D	XLT14-35D
36	XLT09-36D	XLT10-36D	XLT11-36D	XLT12-36D	XLT13-36D	XLT14-36D
37	XLT09-37D	XLT10-37D	XLT11-37D	XLT12-37D	XLT13-37D	XLT14-37D
38	XLT09-38D	XLT10-38D	XLT11-38D	XLT12-38D	XLT13-38D	XLT14-38D
39	XLT09-39D	XLT10-39D	XLT11-39D	XLT12-39D	XLT13-39D	XLT14-39D
40	XLT09-40D	XLT10-40D	XLT11-40D	XLT12-40D	XLT13-40D	XLT14-40D
41	XLT09-41D	XLT10-41D	XLT11-41D	XLT12-41D	XLT13-41D	XLT14-41D
42	XLT09-42D	XLT10-42D	XLT11-42D	XLT12-42D	XLT13-42D	XLT14-42D
43	XLT09-43D	XLT10-43D	XLT11-43D	XLT12-43D	XLT13-43D	XLT14-43D
44	XLT09-44D	XLT10-44D	XLT11-44D	XLT12-44D	XLT13-44D	XLT14-44D

Same Nail for Right & Left Leg.
Use with Instrument Set - AS071/AS071DJ

XL TIBIAL NAIL - CANNULATED (DYNAMIC HOLE)

Length in cm	TITANIUM - Diameter in mm					
	9 mm	10 mm	11 mm	12 mm	13 mm	14 mm
26	Ti-XLT09-26D	Ti-XLT10-26D	Ti-XLT11-26D	Ti-XLT12-26D	Ti-XLT13-26D	Ti-XLT14-26D
27	Ti-XLT09-27D	Ti-XLT10-27D	Ti-XLT11-27D	Ti-XLT12-27D	Ti-XLT13-27D	Ti-XLT14-27D
28	Ti-XLT09-28D	Ti-XLT10-28D	Ti-XLT11-28D	Ti-XLT12-28D	Ti-XLT13-28D	Ti-XLT14-28D
29	Ti-XLT09-29D	Ti-XLT10-29D	Ti-XLT11-29D	Ti-XLT12-29D	Ti-XLT13-29D	Ti-XLT14-29D
30	Ti-XLT09-30D	Ti-XLT10-30D	Ti-XLT11-30D	Ti-XLT12-30D	Ti-XLT13-30D	Ti-XLT14-30D
31	Ti-XLT09-31D	Ti-XLT10-31D	Ti-XLT11-31D	Ti-XLT12-31D	Ti-XLT13-31D	Ti-XLT14-31D
32	Ti-XLT09-32D	Ti-XLT10-32D	Ti-XLT11-32D	Ti-XLT12-32D	Ti-XLT13-32D	Ti-XLT14-32D
33	Ti-XLT09-33D	Ti-XLT10-33D	Ti-XLT11-33D	Ti-XLT12-33D	Ti-XLT13-33D	Ti-XLT14-33D
34	Ti-XLT09-34D	Ti-XLT10-34D	Ti-XLT11-34D	Ti-XLT12-34D	Ti-XLT13-34D	Ti-XLT14-34D
35	Ti-XLT09-35D	Ti-XLT10-35D	Ti-XLT11-35D	Ti-XLT12-35D	Ti-XLT13-35D	Ti-XLT14-35D
36	Ti-XLT09-36D	Ti-XLT10-36D	Ti-XLT11-36D	Ti-XLT12-36D	Ti-XLT13-36D	Ti-XLT14-36D
37	Ti-XLT09-37D	Ti-XLT10-37D	Ti-XLT11-37D	Ti-XLT12-37D	Ti-XLT13-37D	Ti-XLT14-37D
38	Ti-XLT09-38D	Ti-XLT10-38D	Ti-XLT11-38D	Ti-XLT12-38D	Ti-XLT13-38D	Ti-XLT14-38D
39	Ti-XLT09-39D	Ti-XLT10-39D	Ti-XLT11-39D	Ti-XLT12-39D	Ti-XLT13-39D	Ti-XLT14-39D
40	Ti-XLT09-40D	Ti-XLT10-40D	Ti-XLT11-40D	Ti-XLT12-40D	Ti-XLT13-40D	Ti-XLT14-40D
41	Ti-XLT09-41D	Ti-XLT10-41D	Ti-XLT11-41D	Ti-XLT12-41D	Ti-XLT13-41D	Ti-XLT14-41D
42	Ti-XLT09-42D	Ti-XLT10-42D	Ti-XLT11-42D	Ti-XLT12-42D	Ti-XLT13-42D	Ti-XLT14-42D
43	Ti-XLT09-43D	Ti-XLT10-43D	Ti-XLT11-43D	Ti-XLT12-43D	Ti-XLT13-43D	Ti-XLT14-43D
44	Ti-XLT09-44D	Ti-XLT10-44D	Ti-XLT11-44D	Ti-XLT12-44D	Ti-XLT13-44D	Ti-XLT14-44D

Same Nail for Right & Left Leg.
Use with Instrument Set - AS071/AS071DJ



1 Round Hole & 1 Dynamic Hole Lateral to Medial for 4.5mm Locking Bolts



XL TIBIAL NAIL - CANNULATED, LOWER END (DYNAMIC HOLE)

Length in cm	STAINLESS STEEL - Diameter in mm					
	9 mm	10 mm	11 mm	12 mm	13 mm	14 mm
26	XL-LT09-26D	XL-LT10-26D	XL-LT11-26D	XL-LT12-26D	XL-LT13-26D	XL-LT14-26D
27	XL-LT09-27D	XL-LT10-27D	XL-LT11-27D	XL-LT12-27D	XL-LT13-27D	XL-LT14-27D
28	XL-LT09-28D	XL-LT10-28D	XL-LT11-28D	XL-LT12-28D	XL-LT13-28D	XL-LT14-28D
29	XL-LT09-29D	XL-LT10-29D	XL-LT11-29D	XL-LT12-29D	XL-LT13-29D	XL-LT14-29D
30	XL-LT09-30D	XL-LT10-30D	XL-LT11-30D	XL-LT12-30D	XL-LT13-30D	XL-LT14-30D
31	XL-LT09-31D	XL-LT10-31D	XL-LT11-31D	XL-LT12-31D	XL-LT13-31D	XL-LT14-31D
32	XL-LT09-32D	XL-LT10-32D	XL-LT11-32D	XL-LT12-32D	XL-LT13-32D	XL-LT14-32D
33	XL-LT09-33D	XL-LT10-33D	XL-LT11-33D	XL-LT12-33D	XL-LT13-33D	XL-LT14-33D
34	XL-LT09-34D	XL-LT10-34D	XL-LT11-34D	XL-LT12-34D	XL-LT13-34D	XL-LT14-34D
35	XL-LT09-35D	XL-LT10-35D	XL-LT11-35D	XL-LT12-35D	XL-LT13-35D	XL-LT14-35D
36	XL-LT09-36D	XL-LT10-36D	XL-LT11-36D	XL-LT12-36D	XL-LT13-36D	XL-LT14-36D
37	XL-LT09-37D	XL-LT10-37D	XL-LT11-37D	XL-LT12-37D	XL-LT13-37D	XL-LT14-37D
38	XL-LT09-38D	XL-LT10-38D	XL-LT11-38D	XL-LT12-38D	XL-LT13-38D	XL-LT14-38D
39	XL-LT09-39D	XL-LT10-39D	XL-LT11-39D	XL-LT12-39D	XL-LT13-39D	XL-LT14-39D
40	XL-LT09-40D	XL-LT10-40D	XL-LT11-40D	XL-LT12-40D	XL-LT13-40D	XL-LT14-40D
41	XL-LT09-41D	XL-LT10-41D	XL-LT11-41D	XL-LT12-41D	XL-LT13-41D	XL-LT14-41D
42	XL-LT09-42D	XL-LT10-42D	XL-LT11-42D	XL-LT12-42D	XL-LT13-42D	XL-LT14-42D
43	XL-LT09-43D	XL-LT10-43D	XL-LT11-43D	XL-LT12-43D	XL-LT13-43D	XL-LT14-43D
44	XL-LT09-44D	XL-LT10-44D	XL-LT11-44D	XL-LT12-44D	XL-LT13-44D	XL-LT14-44D

Same Nail for Right & Left Leg.
Use with Instrument Set - AS071/AS071DJ

1 Round Hole & 1 Dynamic Hole Lateral to Medial for 4.5mm Locking Bolts



XL TIBIAL NAIL - CANNULATED, LOWER END (DYNAMIC HOLE)

Length in cm	TITANIUM - Diameter in mm					
	9 mm	10 mm	11 mm	12 mm	13 mm	14 mm
26	Ti-XL-LT09-26D	Ti-XL-LT10-26D	Ti-XL-LT11-26D	Ti-XL-LT12-26D	Ti-XL-LT13-26D	Ti-XL-LT14-26D
27	Ti-XL-LT09-27D	Ti-XL-LT10-27D	Ti-XL-LT11-27D	Ti-XL-LT12-27D	Ti-XL-LT13-27D	Ti-XL-LT14-27D
28	Ti-XL-LT09-28D	Ti-XL-LT10-28D	Ti-XL-LT11-28D	Ti-XL-LT12-28D	Ti-XL-LT13-28D	Ti-XL-LT14-28D
29	Ti-XL-LT09-29D	Ti-XL-LT10-29D	Ti-XL-LT11-29D	Ti-XL-LT12-29D	Ti-XL-LT13-29D	Ti-XL-LT14-29D
30	Ti-XL-LT09-30D	Ti-XL-LT10-30D	Ti-XL-LT11-30D	Ti-XL-LT12-30D	Ti-XL-LT13-30D	Ti-XL-LT14-30D
31	Ti-XL-LT09-31D	Ti-XL-LT10-31D	Ti-XL-LT11-31D	Ti-XL-LT12-31D	Ti-XL-LT13-31D	Ti-XL-LT14-31D
32	Ti-XL-LT09-32D	Ti-XL-LT10-32D	Ti-XL-LT11-32D	Ti-XL-LT12-32D	Ti-XL-LT13-32D	Ti-XL-LT14-32D
33	Ti-XL-LT09-33D	Ti-XL-LT10-33D	Ti-XL-LT11-33D	Ti-XL-LT12-33D	Ti-XL-LT13-33D	Ti-XL-LT14-33D
34	Ti-XL-LT09-34D	Ti-XL-LT10-34D	Ti-XL-LT11-34D	Ti-XL-LT12-34D	Ti-XL-LT13-34D	Ti-XL-LT14-34D
35	Ti-XL-LT09-35D	Ti-XL-LT10-35D	Ti-XL-LT11-35D	Ti-XL-LT12-35D	Ti-XL-LT13-35D	Ti-XL-LT14-35D
36	Ti-XL-LT09-36D	Ti-XL-LT10-36D	Ti-XL-LT11-36D	Ti-XL-LT12-36D	Ti-XL-LT13-36D	Ti-XL-LT14-36D
37	Ti-XL-LT09-37D	Ti-XL-LT10-37D	Ti-XL-LT11-37D	Ti-XL-LT12-37D	Ti-XL-LT13-37D	Ti-XL-LT14-37D
38	Ti-XL-LT09-38D	Ti-XL-LT10-38D	Ti-XL-LT11-38D	Ti-XL-LT12-38D	Ti-XL-LT13-38D	Ti-XL-LT14-38D
39	Ti-XL-LT09-39D	Ti-XL-LT10-39D	Ti-XL-LT11-39D	Ti-XL-LT12-39D	Ti-XL-LT13-39D	Ti-XL-LT14-39D
40	Ti-XL-LT09-40D	Ti-XL-LT10-40D	Ti-XL-LT11-40D	Ti-XL-LT12-40D	Ti-XL-LT13-40D	Ti-XL-LT14-40D
41	Ti-XL-LT09-41D	Ti-XL-LT10-41D	Ti-XL-LT11-41D	Ti-XL-LT12-41D	Ti-XL-LT13-41D	Ti-XL-LT14-41D
42	Ti-XL-LT09-42D	Ti-XL-LT10-42D	Ti-XL-LT11-42D	Ti-XL-LT12-42D	Ti-XL-LT13-42D	Ti-XL-LT14-42D
43	Ti-XL-LT09-43D	Ti-XL-LT10-43D	Ti-XL-LT11-43D	Ti-XL-LT12-43D	Ti-XL-LT13-43D	Ti-XL-LT14-43D
44	Ti-XL-LT09-44D	Ti-XL-LT10-44D	Ti-XL-LT11-44D	Ti-XL-LT12-44D	Ti-XL-LT13-44D	Ti-XL-LT14-44D

Same Nail for Right & Left Leg.
Use with Instrument Set - AS071/AS071DJ

1 Distal Hole Lateral to Medial for 4.5mm Locking Bolt

1 Distal Hole Anterior to Posterior for 4.5mm Locking Bolt

1 Distal Hole Anterior to Posterior for 4.5mm Locking Bolt

1 Distal Hole Lateral to Medial for 4.5mm Locking Bolt



**XL TIBIAL NAIL - UNREAMED
(STANDARD HOLE)**

Length in cm	S.S. - Diameter in mm	
	8 mm	9 mm
26	XLUTN08-26	XLUTN09-26
27	XLUTN08-27	XLUTN09-27
28	XLUTN08-28	XLUTN09-28
29	XLUTN08-29	XLUTN09-29
30	XLUTN08-30	XLUTN09-30
31	XLUTN08-31	XLUTN09-31
32	XLUTN08-32	XLUTN09-32
33	XLUTN08-33	XLUTN09-33
34	XLUTN08-34	XLUTN09-34
35	XLUTN08-35	XLUTN09-35
36	XLUTN08-36	XLUTN09-36
37	XLUTN08-37	XLUTN09-37
38	XLUTN08-38	XLUTN09-38
39	XLUTN08-39	XLUTN09-39
40	XLUTN08-40	XLUTN09-40
41	XLUTN08-41	XLUTN09-41
42	XLUTN08-42	XLUTN09-42
43	XLUTN08-43	XLUTN09-43
44	XLUTN08-44	XLUTN09-44

Length in cm	TITANIUM - Diameter in mm	
	8 mm	9 mm
26	TI-XLUTN08-26	TI-XLUTN09-26
27	TI-XLUTN08-27	TI-XLUTN09-27
28	TI-XLUTN08-28	TI-XLUTN09-28
29	TI-XLUTN08-29	TI-XLUTN09-29
30	TI-XLUTN08-30	TI-XLUTN09-30
31	TI-XLUTN08-31	TI-XLUTN09-31
32	TI-XLUTN08-32	TI-XLUTN09-32
33	TI-XLUTN08-33	TI-XLUTN09-33
34	TI-XLUTN08-34	TI-XLUTN09-34
35	TI-XLUTN08-35	TI-XLUTN09-35
36	TI-XLUTN08-36	TI-XLUTN09-36
37	TI-XLUTN08-37	TI-XLUTN09-37
38	TI-XLUTN08-38	TI-XLUTN09-38
39	TI-XLUTN08-39	TI-XLUTN09-39
40	TI-XLUTN08-40	TI-XLUTN09-40
41	TI-XLUTN08-41	TI-XLUTN09-41
42	TI-XLUTN08-42	TI-XLUTN09-42
43	TI-XLUTN08-43	TI-XLUTN09-43
44	TI-XLUTN08-44	TI-XLUTN09-44

Same Nail for Right & Left Leg.
Use with Instrument Set - AS071/AS071DJ



1 Round Hole & 1 Dynamic Hole
Lateral to Medial for 4.5mm Locking Bolts

Distal Holes Lateral to Medial
for 4.5mm Locking Bolt



1 Round Hole & 1 Dynamic Hole
Lateral to Medial for 4.5mm Locking Bolts

Distal Holes Lateral to Medial
for 4.5mm Locking Bolt

XL TIBIAL NAIL - UNREAMED (DYNAMIC HOLE)

Length in cm	S.S. - Diameter in mm		Length in cm	TITANIUM - Diameter in mm	
	8 mm	9 mm		8 mm	9 mm
26	XLUTN08-26D	XLUTN09-26D	26	TI-XLUTN08-26D	TI-XLUTN09-26D
27	XLUTN08-27D	XLUTN09-27D	27	TI-XLUTN08-27D	TI-XLUTN09-27D
28	XLUTN08-28D	XLUTN09-28D	28	TI-XLUTN08-28D	TI-XLUTN09-28D
29	XLUTN08-29D	XLUTN09-29D	29	TI-XLUTN08-29D	TI-XLUTN09-29D
30	XLUTN08-30D	XLUTN09-30D	30	TI-XLUTN08-30D	TI-XLUTN09-30D
31	XLUTN08-31D	XLUTN09-31D	31	TI-XLUTN08-31D	TI-XLUTN09-31D
32	XLUTN08-32D	XLUTN09-32D	32	TI-XLUTN08-32D	TI-XLUTN09-32D
33	XLUTN08-33D	XLUTN09-33D	33	TI-XLUTN08-33D	TI-XLUTN09-33D
34	XLUTN08-34D	XLUTN09-34D	34	TI-XLUTN08-34D	TI-XLUTN09-34D
35	XLUTN08-35D	XLUTN09-35D	35	TI-XLUTN08-35D	TI-XLUTN09-35D
36	XLUTN08-36D	XLUTN09-36D	36	TI-XLUTN08-36D	TI-XLUTN09-36D
37	XLUTN08-37D	XLUTN09-37D	37	TI-XLUTN08-37D	TI-XLUTN09-37D
38	XLUTN08-38D	XLUTN09-38D	38	TI-XLUTN08-38D	TI-XLUTN09-38D
39	XLUTN08-39D	XLUTN09-39D	39	TI-XLUTN08-39D	TI-XLUTN09-39D
40	XLUTN08-40D	XLUTN09-40D	40	TI-XLUTN08-40D	TI-XLUTN09-40D
41	XLUTN08-41D	XLUTN09-41D	41	TI-XLUTN08-41D	TI-XLUTN09-41D
42	XLUTN08-42D	XLUTN09-42D	42	TI-XLUTN08-42D	TI-XLUTN09-42D
43	XLUTN08-43D	XLUTN09-43D	43	TI-XLUTN08-43D	TI-XLUTN09-43D
44	XLUTN08-44D	XLUTN09-44D	44	TI-XLUTN08-44D	TI-XLUTN09-44D

Same Nail for Right & Left Leg.

Use with Instrument Set - AS071/AS071DJ



**XL TIBIAL NAIL - UNREAMED
LOWER END (DYNAMIC HOLE)**

Length in cm	S.S. - Diameter in mm	
	8 mm	9 mm
26	XLUTL08-26D	XLUTL09-26D
27	XLUTL08-27D	XLUTL09-27D
28	XLUTL08-28D	XLUTL09-28D
29	XLUTL08-29D	XLUTL09-29D
30	XLUTL08-30D	XLUTL09-30D
31	XLUTL08-31D	XLUTL09-31D
32	XLUTL08-32D	XLUTL09-32D
33	XLUTL08-33D	XLUTL09-33D
34	XLUTL08-34D	XLUTL09-34D
35	XLUTL08-35D	XLUTL09-35D
36	XLUTL08-36D	XLUTL09-36D
37	XLUTL08-37D	XLUTL09-37D
38	XLUTL08-38D	XLUTL09-38D
39	XLUTL08-39D	XLUTL09-39D
40	XLUTL08-40D	XLUTL09-40D
41	XLUTL08-41D	XLUTL09-41D
42	XLUTL08-42D	XLUTL09-42D
43	XLUTL08-43D	XLUTL09-43D
44	XLUTL08-44D	XLUTL09-44D

Length in cm	TITANIUM - Diameter in mm	
	8 mm	9 mm
26	Ti-XLUTL08-26D	Ti-XLUTL09-26D
27	Ti-XLUTL08-27D	Ti-XLUTL09-27D
28	Ti-XLUTL08-28D	Ti-XLUTL09-28D
29	Ti-XLUTL08-29D	Ti-XLUTL09-29D
30	Ti-XLUTL08-30D	Ti-XLUTL09-30D
31	Ti-XLUTL08-31D	Ti-XLUTL09-31D
32	Ti-XLUTL08-32D	Ti-XLUTL09-32D
33	Ti-XLUTL08-33D	Ti-XLUTL09-33D
34	Ti-XLUTL08-34D	Ti-XLUTL09-34D
35	Ti-XLUTL08-35D	Ti-XLUTL09-35D
36	Ti-XLUTL08-36D	Ti-XLUTL09-36D
37	Ti-XLUTL08-37D	Ti-XLUTL09-37D
38	Ti-XLUTL08-38D	Ti-XLUTL09-38D
39	Ti-XLUTL08-39D	Ti-XLUTL09-39D
40	Ti-XLUTL08-40D	Ti-XLUTL09-40D
41	Ti-XLUTL08-41D	Ti-XLUTL09-41D
42	Ti-XLUTL08-42D	Ti-XLUTL09-42D
43	Ti-XLUTL08-43D	Ti-XLUTL09-43D
44	Ti-XLUTL08-44D	Ti-XLUTL09-44D

Same Nail for Right & Left Leg.
Use with Instrument Set - AS071/AS071DJ



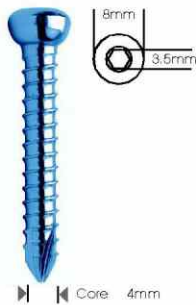

YouTube www.TV.ortho.in/149

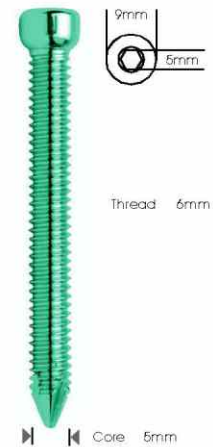
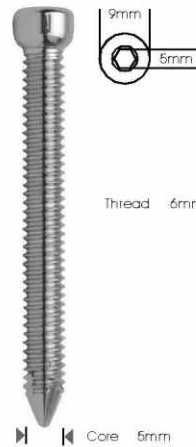

LOCKING BOLT, 4.5MM (SELF TAPPING)

Length in mm.	STAINLESS STEEL
24	045-24
26	045-26
28	045-28
30	045-30
32	045-32
34	045-34
36	045-36
38	045-38
40	045-40
42	045-42
44	045-44
46	045-46
48	045-48
50	045-50
55	045-55
60	045-60
65	045-65
70	045-70
75	045-75
80	045-80
85	045-85
90	045-90
95	045-95
100	045-100
105	045-105
110	045-110
115	045-115
120	045-120

Drill Bit: 3.5mm

Length in mm.	TITANIUM
24	Ti-045-24
26	Ti-045-26
28	Ti-045-28
30	Ti-045-30
32	Ti-045-32
34	Ti-045-34
36	Ti-045-36
38	Ti-045-38
40	Ti-045-40
42	Ti-045-42
44	Ti-045-44
46	Ti-045-46
48	Ti-045-48
50	Ti-045-50
55	Ti-045-55
60	Ti-045-60
65	Ti-045-65
70	Ti-045-70
75	Ti-045-75
80	Ti-045-80
85	Ti-045-85
90	Ti-045-90
95	Ti-045-95
100	Ti-045-100
105	Ti-045-105
110	Ti-045-110
115	Ti-045-115
120	Ti-045-120

Drill Bit: 3.5mm

LOCKING BOLT, 6MM (SELF TAPPING)

Length in mm.	STAINLESS STEEL
40	050-40
45	050-45
50	050-50
55	050-55
60	050-60
65	050-65
70	050-70
75	050-75
80	050-80
85	050-85
90	050-90
95	050-95
100	050-100
105	050-105
110	050-110
115	050-115
120	050-120

Drill Bit : 5mm

Length in mm.	TITANIUM
40	Ti-050-40
45	Ti-050-45
50	Ti-050-50
55	Ti-050-55
60	Ti-050-60
65	Ti-050-65
70	Ti-050-70
75	Ti-050-75
80	Ti-050-80
85	Ti-050-85
90	Ti-050-90
95	Ti-050-95
100	Ti-050-100
105	Ti-050-105
110	Ti-050-110
115	Ti-050-115
120	Ti-050-120

Drill Bit : 5mm



END CAP FOR XL & MULTI-FIX NAILS

Nails	Stainless Steel
Tibial	XLT-045-SS
Femoral	XLF-046-SS

Nails	Titanium
Tibial	XLT-045-Ti
Femoral	XLF-046-Ti

YouTube www.TV.ortho.in/16581

□ FEMORAL ILN IMPLANTS SET, S.S.

YouTube www.TV.ortho.in/23311

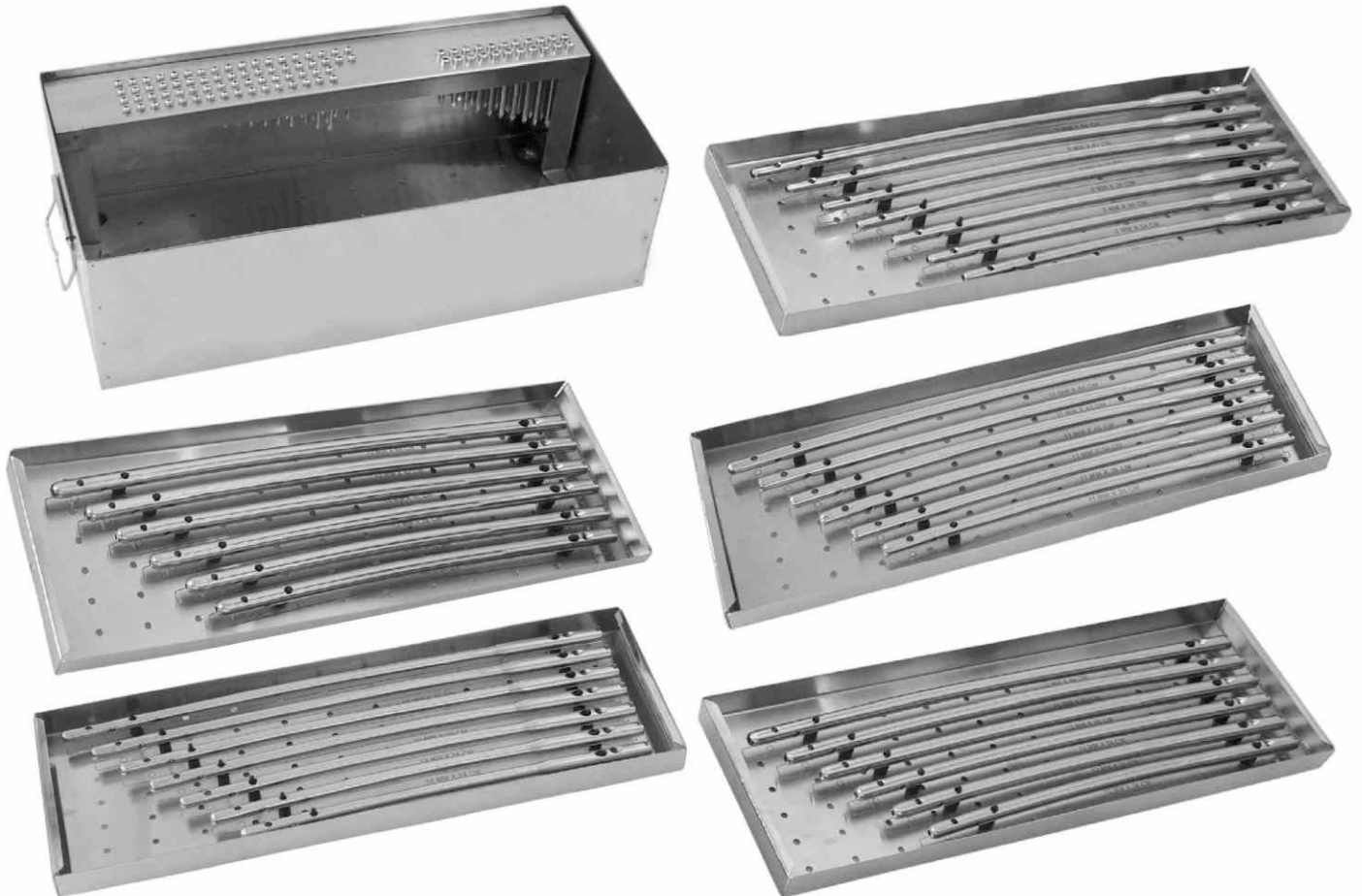

FEMORAL ILN IMPLANTS SET, S.S.

<i>Set Consisting of:</i>		Units
Femoral Nails		
9mm Dia	1 each, Length 32, 34, 36, 38, 40, 42, 44cm	7
10mm Dia	1 each, Length 32, 34, 36, 38, 40, 42, 44cm	7
11mm Dia	1 each, Length 34, 36, 38, 40, 42, 44cm	6
12mm Dia	1 each, Length 34, 36, 38, 40, 42, 44cm	6
13mm Dia	1 each, Length 34, 36, 38, 40, 42, 44cm	6
Locking Bolt 4.5mm Dia	4 each, Length 24, 26, 28, 30, 32, 34, 36, 38, 40, 42, 44, 46, 48, 50, 55, 60mm	64
	2 each, Length 65, 70mm	4
Locking Bolt 6.0mm Dia	2 each, Length 50, 55, 60, 65, 70, 75, 80, 85, 90, 95, 100mm	22
AS095	FEMORAL NAILS IMPLANTS SET (XL Femoral Nails), diameter and lengths as above	
AS195	FEMORAL NAILS IMPLANTS SET (MULTI-FIX Femoral Nails), diameter and lengths as above	
903.085	Empty Container for FEMORAL NAILS IMPLANTS SET	

□ TIBIAL ILN IMPLANTS SET, S.S.

YouTube www.TV.ortho.in/23347

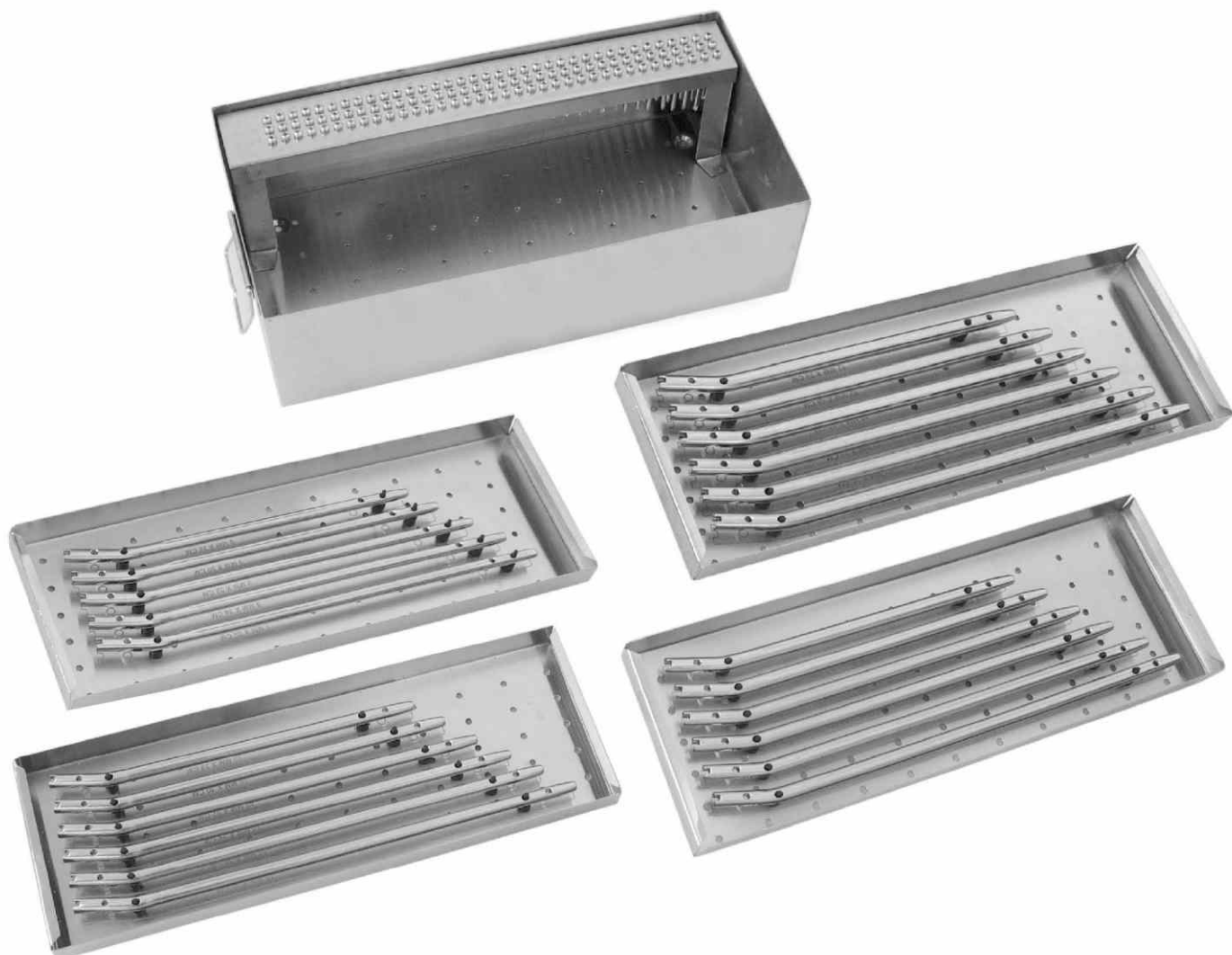

TIBIAL ILN IMPLANTS SET, S.S.

Set Consisting of:

Units

	Tibial Nails	
	9mm Dia	
	1 each, Length 28, 30, 32, 34, 36cm	5
	10mm Dia	
	1 each, Length 28, 30, 32, 34, 36, 38cm	6
	11mm Dia	
	1 each, Length 28, 30, 32, 34, 36, 38cm	6
	12mm Dia	
	1 each, Length 28, 30, 32, 34, 36, 38cm	6
	Locking Bolt 4.5mm Dia	
	6 each, Length 24, 26, 28, 30, 32, 34, 36, 38, 40, 42, 44, 46, 48, 50, 55, 60, 65, 70mm	108
AS099	TIBIAL NAILS IMPLANTS SET (XL Tibial Nails), diameter and lengths as above	
AS109	TIBIAL NAILS IMPLANTS SET (MULTI-FIX Tibial Nails), diameter and lengths as above	
903.080	Empty Container for TIBIAL NAILS IMPLANTS SET	

□ INSTRUMENTS SET FOR XL / MULTI-FIX TIBIAL & FEMORAL NAILS, S.S.



YouTube www.TV.ortho.in/11031

AS071 INSTRUMENTS SET FOR XL / MULTI-FIX TIBIAL & FEMORAL NAILS, S.S.

Set Consisting of:			Units	Set Consisting of:			Units
507.01	Diamond Pointed Bone Awl for Femur	1	507.16	Depth Gauge	1		
507.02	Tissue Protector	1	208.10	Extra Long Hexagonal Screws Driver for 4.5mm Locking Bolt	1		
507.04	Medullary Tube	1	208.16	Screw Driver for 6mm Locking Bolt	1		
507.05	Reaming Rod 3.0mm Dia	1	507.115	Internal Fracture Alignment Device	1		
507.08	Guide Rod 3.0mm Dia	1	507.104	Proximal Jig for XL/MULTI-FIX Tibial Nails	1		
507.103	Guide Rod / Reaming Rod Introducer	1	507.105	Proximal Jig for XL/MULTI-FIX Femoral Nails	1		
208.15	Diamond Pointed Bone Awl for Tibia	1	507.106	Hex Cap (for Tibia & Femur Proximal Jig Assembly)	1		
507.038	Flexible reaming Shaft with fixed reamer dia 8.0mm	1	507.30	Jig Assembly Connecting Part	1		
507.03	Flexible Reamer Shaft only (For Reamer Head upto 13mm.)	2	507.109	Nail Holding Bolt for XL/MULTI-FIX Tibial Nails	2		
507.23	Flexible Reamer Shaft only (For Reamer Head from 13.5mm to 15mm.)	1	507.108	Nail Holding Bolt for XL/MULTI-FIX Femoral Nails	2		
510.9	Reamer Heads (Medullary), 9mm.	1	507.24	Universal Socket Wrench, 10mm	1		
510.95	Reamer Heads (Medullary), 9.5mm.	1	507.28	Hammering Device	1		
510.10	Reamer Heads (Medullary), 10mm.	1	507.84	Extractor - Impactor	1		
510.105	Reamer Heads (Medullary), 10.5mm	1	507.66	Drill Sleeve for 6mm Locking Bolt	1		
510.11	Reamer Heads (Medullary), 11mm.	1	507.64	Drill Sleeve of 4.5mm Locking Bolt	1		
510.115	Reamer Heads (Medullary), 11.5mm.	1	507.111	Protection Sleeve for 4.5mm Locking Bolt	1		
510.12	Reamer Heads (Medullary), 12mm.	1	507.112	Protection Sleeve for 6mm Locking Bolt	1		
510.125	Reamer Heads (Medullary), 12.5mm.	1	507.113	Trocar	1		
510.13	Reamer Heads (Medullary), 13mm	1	261.650	Drill Bit- SS - Plain Shank, Dia.:5.0mm, L250mm	2		
510.135	Reamer Heads (Medullary), 13.5mm	1	261.637	Drill Bits - SS, Dia. 3.5mm x 250mm, Straight Shank, with Trocar End	2		
510.14	Reamer Heads (Medullary), 14mm	1	507.116	Tomy Bar	2		
510.145	Reamer Heads (Medullary), 14.5mm	1	507.110	Spanner SS, 10mm	1		
510.15	Reamer Heads (Medullary), 15mm	1	901.005	Empty Container	1		

OPTIONAL INSTRUMENTS (To be Ordered Separately)

	Units	
507.14	Freehand Aiming Device for Distal Locking	1
507.100	Distal Jig for XL/MULTI-FIX Tibial & XL/MULTI-FIX Femur Nails	1
507.129	Base Plate for both XL/MULTI-FIX Tibial & XL/MULTI-FIX Femoral	1
507.102T	Sliding Sleeves for XL/MULTI-FIX Tibia Jig Assembly	1
507.102F	Sliding Sleeves for XL/MULTI-FIX Femoral Jig Assembly	1
507.901	Instrument for Removal of Broken Nails	1

AS071DJ INSTRUMENTS SET FOR XL / MULTI-FIX TIBIAL & FEMORAL NAILS WITH DISTAL JIG (Contents same as AS071 plus with the following):

507.100	Distal Jig for XL/MULTI-FIX Tibial & XL/MULTI-FIX Femur Nails	1
507.129	Base Plate for both XL/MULTI-FIX Tibial & XL/MULTI-FIX Femoral	1
507.102T	Sliding Sleeves for XL/MULTI-FIX Tibia Jig Assembly	1
507.102F	Sliding Sleeves for XL/MULTI-FIX Femur Proximal Jig Assembly	1



Flexible Reaming Shaft with Fixed Reamer, Dia. 8.0mm.
Code No.: 507.038



Medullary Reamer
(Size: 9 to 15mm with 0.5mm difference)
Code No.: 510.9 to 510.15



Flexible Reaming Shaft
Code No.: 507.03 (for Reamer Head 9 to 13mm)
Code No.: 507.23 (for Reamer Head 13.5 to 15mm)



Diamond Pointed Bone Awl for Femoral
Code No.: 507.01



Diamond Pointed Bone Awl for Tibia
Code No.: 208.15



Tissue Protector
Code No.: 507.02



Guide Rod 3.0mm Dia.
Code No.: 507.08



Reaming Rod 3.0mm Dia.
Code No.: 507.05



Tomy Bar
Code No.: 507.116

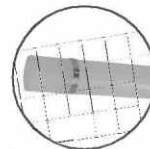

Guide Rod / Reaming Rod Introducer
Code No.: 507.103



Depth Gauge (Extra Large)
Code No.: 507.16



Medullary Tube
Code No.: 507.04



Extra Long Hexagonal Screw Driver - 3.5mm Tip
Code No.: 208.10



Internal Fracture Alignment Device
Code No.: 507.115



Extra Large Hexagonal Screw Driver (T-Type) for 6mm Locking Bolt
Code No.: 208.16



Universal Socket Wrench, 10mm
Code No.: 507.24



Extractor - Impactor
Code No.: 507.84



Spanner, 10mm, S.S.
Code No.: 507.110



Drill Bits, 5.0mm x 250mm, Straight Shank, with Trocar End
Code No.: 261.650



Drill Bits, 3.5mm x 250mm, Straight Shank, with Trocar End
Code No.: 261.637



**Proximal Jig
for XL/Multi-Fix Tibial Nails**
Code No.: 507.104



Hex Cap
Code No.: 507.106



Jig Assembly Connecting Part
Code No.: 507.30



Drill Sleeve for 6mm Locking Bolt
Code No.: 507.66



**Proximal Jig
for XL/Multi-Fix Femoral Nails**
Code No.: 507.105



Hammering Device
Code No.: 507.28



**Protection Sleeve
for 6mm Locking Bolt**
Code No.: 507.112



**Nail Holding Bolt
for XL/Multi-Fix Femoral Nails**
Code No.: 507.108



**Nail Holding Bolt
for XL/Multi-Fix Tibial Nails**
Code No.: 507.109



Trocar
Code No.: 507.113



Drill Sleeve of 4.5mm Locking Bolt
Code No.: 507.64



Protection Sleeve for 4.5mm Locking Bolt
Code No.: 507.111

OPTIONAL INSTRUMENTS FOR XL/MULTI-FIX NAILS

(To be Ordered Separately)



**Sliding Sleeves
(for XL/Multi-Fix Tibia Proximal Jig Assembly)**
Code No.: 507.102T



**Sliding Sleeves
(for XL/Multi-Fix Femur Proximal Jig Assembly)**
Code No.: 507.102F



**Base Plate (for both XL/Multi-Fix Tibial &
XL/Multi-Fix Femoral)**
Code No.: 507.129

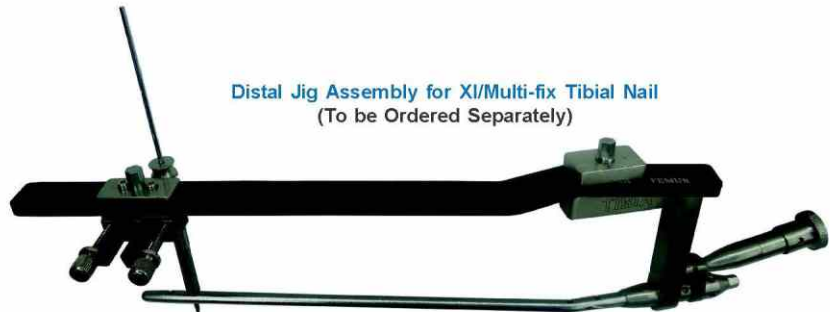

Distal Jig Assembly for XI/Multi-fix Tibial Nail
(To be Ordered Separately)



Distal Jig Assembly for XI/Multi-fix Femur Nail
(To be Ordered Separately)



Distal Jig for XL/Multi-Fix Tibial & Femur Nails
Code No.: 507.100



Instrument for Removal of Broken Nails
Code No.: 507.901



Free Hand Aiming Device
Code No.: 507.14

2 Distal Holes Lateral to medial
for 4.9mm Locking Bolts

2 Proximal Holes Lateral to medial
with 1 Dynamic Hole
for 4.9mm Locking Bolts



UNIVERSAL FEMORAL NAIL WITH PROXIMAL DYNAMIC HOLE

Length in cm.	STAINLESS STEEL - Diameter in mm					
	9 mm	10 mm	11 mm	12 mm	13 mm	14 mm
32	IF09-32	IFD10-32	IFD11-32	IFD12-32	IFD13-32	IFD14-32
33	IF09-33	IFD10-33	IFD11-33	IFD12-33	IFD13-33	IFD14-33
34	IF09-34	IFD10-34	IFD11-34	IFD12-34	IFD13-34	IFD14-34
35	IF09-35	IFD10-35	IFD11-35	IFD12-35	IFD13-35	IFD14-35
36	IF09-36	IFD10-36	IFD11-36	IFD12-36	IFD13-36	IFD14-36
37	IF09-37	IFD10-37	IFD11-37	IFD12-37	IFD13-37	IFD14-37
38	IF09-38	IFD10-38	IFD11-38	IFD12-38	IFD13-38	IFD14-38
39	IF09-39	IFD10-39	IFD11-39	IFD12-39	IFD13-39	IFD14-39
40	IF09-40	IFD10-40	IFD11-40	IFD12-40	IFD13-40	IFD14-40
41	IF09-41	IFD10-41	IFD11-41	IFD12-41	IFD13-41	IFD14-41
42	IF09-42	IFD10-42	IFD11-42	IFD12-42	IFD13-42	IFD14-42
43	IF09-43	IFD10-43	IFD11-43	IFD12-43	IFD13-43	IFD14-43
44	IF09-44	IFD10-44	IFD11-44	IFD12-44	IFD13-44	IFD14-44
45	IF09-45	IFD10-45	IFD11-45	IFD12-45	IFD13-45	IFD14-45
46	IF09-46	IFD10-46	IFD11-46	IFD12-46	IFD13-46	IFD14-46

Same Nail for Right & Left Leg.
In 9mm Dia Nail, Dynamic Compression hole shall not be available.
9mm Dia Nail shall be available only with round hole.
9mm Dia Nail to be used with 2.5mm Guide Wire.
Use with Instrument Sets - AS031 & AS031DJ.

2 Distal Holes Lateral to medial
for 4.9mm Locking Bolts

2 Proximal Holes Lateral to medial
with 1 Dynamic Hole
for 4.9mm Locking Bolts



UNIVERSAL TIBIAL NAIL WITH PROXIMAL DYNAMIC HOLE

Length in cm.	STAINLESS STEEL - Diameter in mm					
	9 mm	10 mm	11 mm	12 mm	13 mm	14 mm
26	IT09-26	ITD10-26	ITD11-26	ITD12-26	ITD13-26	ITD14-26
27	IT09-27	ITD10-27	ITD11-27	ITD12-27	ITD13-27	ITD14-27
28	IT09-28	ITD10-28	ITD11-28	ITD12-28	ITD13-28	ITD14-28
29	IT09-29	ITD10-29	ITD11-29	ITD12-29	ITD13-29	ITD14-29
30	IT09-30	ITD10-30	ITD11-30	ITD12-30	ITD13-30	ITD14-30
31	IT09-31	ITD10-31	ITD11-31	ITD12-31	ITD13-31	ITD14-31
32	IT09-32	ITD10-32	ITD11-32	ITD12-32	ITD13-32	ITD14-32
33	IT09-33	ITD10-33	ITD11-33	ITD12-33	ITD13-33	ITD14-33
34	IT09-34	ITD10-34	ITD11-34	ITD12-34	ITD13-34	ITD14-34
35	IT09-35	ITD10-35	ITD11-35	ITD12-35	ITD13-35	ITD14-35
36	IT09-36	ITD10-36	ITD11-36	ITD12-36	ITD13-36	ITD14-36
37	IT09-37	ITD10-37	ITD11-37	ITD12-37	ITD13-37	ITD14-37
38	IT09-38	ITD10-38	ITD11-38	ITD12-38	ITD13-38	ITD14-38
39	IT09-39	ITD10-39	ITD11-39	ITD12-39	ITD13-39	ITD14-39
40	IT09-40	ITD10-40	ITD11-40	ITD12-40	ITD13-40	ITD14-40
41	IT09-41	ITD10-41	ITD11-41	ITD12-41	ITD13-41	ITD14-41
42	IT09-42	ITD10-42	ITD11-42	ITD12-42	ITD13-42	ITD14-42
43	IT09-43	ITD10-43	ITD11-43	ITD12-43	ITD13-43	ITD14-43
44	IT09-44	ITD10-44	ITD11-44	ITD12-44	ITD13-44	ITD14-44

Same Nail for Right & Left Leg.
In 9mm Dia Nail, Dynamic Compression hole shall not be available.
9mm Dia Nail shall be available only with round hole.
9mm Dia Nail to be used with 2.5mm Guide Wire.
Use with Instrument Sets - AS031 & AS031DJ.

LOCKING BOLT, 4.9MM, (SELF TAPPING)

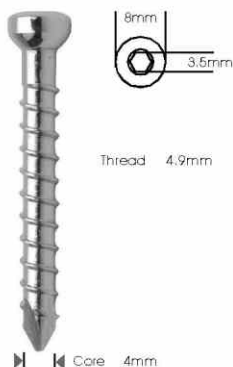

Core 4mm

Note:
To ensure safe hold in the far Cortex, a locking bolt 2mm longer than measured has to be chosen to allow for the trocar tip.
Drill Bit to be used: 4mm

YouTube www.TV.ortho.in/23218

Length mm	Code S.S.
24	040-24
26	040-26
28	040-28
30	040-30
32	040-32
34	040-34
36	040-36
38	040-38
40	040-40
42	040-42
44	040-44
46	040-46
48	040-48
50	040-50
52	040-52
54	040-54
56	040-56
58	040-58
60	040-60
65	040-65
70	040-70
75	040-75
80	040-80
85	040-85
90	040-90
95	040-95
100	040-100



END CAP FOR ALL UNIVERSAL NAILS

Stainless Steel	
Code No.	Used with Nails
042-109	9.0mm Dia.
042-110	10.0mm Dia.
042-111	11.0mm Dia.
042-112	12.0mm Dia.
042-113	13.0mm Dia.
042-114	14.0mm Dia.

YouTube www.TV.ortho.in/23219

INSTRUMENTS SET FOR UNIVERSAL TIBIAL & FEMORAL NAILS, S.S.



Code No.: AS031 / AS031DJ

AS031 INSTRUMENTS SET FOR UNIVERSAL TIBIAL & UNIVERSAL FEMORAL NAILS, S.S.

Set Consisting of:		Units
507.01	Bone Awl	1
507.02	Tissue Protector	1
507.04	Medullary Tube	1
507.05-9	Reaming Rod 2.5mm Dia (to be used with only 9.0mm dia nails)	1
507.05	Reaming Rod 3.0mm Dia	1
507.08-9	Guide Rod 2.5mm Dia (to be used with only 9.0mm dia nails)	1
507.08	Guide Rod 3.0mm Dia	1
507.103	Guide Rod / Reaming Rod Introducer	1
507.038	Flexible reaming Shaft with fixed reamer dia 8.0mm	1
507.03	Flexible Reamer Shaft only (For Reamer Head upto 13mm.)	2
507.23	Flexible Reamer Shaft only (For Reamer Head from 13.5mm to 15mm.)	1
510.9	Reamer Heads (Medullary), 9, 9.5, to 10, 10.5, 11, 11.5, 12, 12.5, 13mm,	1 set
510.13	Set of 9 pieces	
510.135	Reamer Heads (Medullary), to 13.5, 14, 14.5, 15mm,	1 set
510.15	Set of 4 pieces	
507.16	Depth Gauge	1
208.10	Extra Long Hexagonal Screws Driver	1
507.115	Internal Fracture Alignment Device	1
507.06	Holding Forceps for Reaming Rod	1
507.09	Cannulated Socket Wrench 11mm	1
507.10	Curved Driving Piece with Head	1
507.11	Cannulated Extractor / Impactor - Set of 3 Pcs (A) Hammer	1
	(B) Handle	1
	(C) Guide Rod	1
507.12	Proximal Jig	1
507.13	Conical Bolt with Two nuts	1
507.17	Protection Sleeve, 8mm (ID.), 11mm (OD.)	1
507.18	Drill Sleeve 3.2mm (ID.), 8mm (OD.)	1
507.19	Drill Sleeve 4.5mm (ID.), 8mm (OD.)	1
260.501	Drill Bit 4.0 x 4.5mm Dia (Quick Coupling), Length 250mm	2
260.325	Drill Bit 3.2mm Dia (Quick Coupling), Length 200mm	1
507.113	Trocar	1
507.116	Tomy Bar	2
507.99	Spanner SS, 11mm	1
507.1001	Spanner SS, 21mm	1
901.001	Empty Container	

OPTIONAL INSTRUMENTS (To be Ordered Separately)

	Units	
507.14	Freehand Aiming Device for Distal Locking	1
AS031DJ INSTRUMENTS SET FOR UNIVERSAL TIBIAL & UNIVERSAL FEMORAL NAILS WITH DISTAL JIG (Contents same as AS031 but with the following) :		
507.160	Distal Jig for Universal Tibial Nails	1
507.162	Distal Jig for Universal Femur Nails	1
507.165	Base Plate (for both Universal Tibial & Femoral Nails)	1
507.167	Sliding Sleeves (for both Universal Tibial & Femoral Nails)	2



Bone Awl
Code No.: 507.01



Tissue Protector
Code No.: 507.02

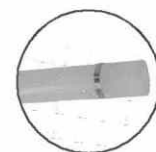

Medullary Tube
Code No.: 507.04

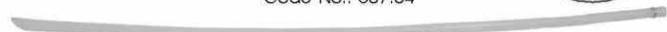

Reaming Rod 2.5mm Dia. (to be used with only 9.0mm dia nails)
Code No.: 507.05-9



Reaming Rod 3.0mm Dia.
Code No.: 507.05



Guide Rod 2.5mm Dia. (to be used with only 9.0mm dia nails)
Code No.: 507.08-9



Guide Rod 3.0mm Dia.
Code No.: 507.08



Depth Gauge (Extra Large)
Code No.: 507.16



Flexible Reaming Shaft with Fixed Reamer, Dia. 8.0mm.
Code No.: 507.038



Medullary Reamer
(Size: 9 to 15mm with 0.5mm difference)
Code No.: 510.9 to 510.15



Flexible Reaming Shaft
Code No.: 507.03 (for Reamer Head 9 to 13mm)
Code No.: 507.23 (for Reamer Head 13.5 to 15mm)



Extra Long Hexagonal Screw Driver, 3.5mm Tip
Code No.: 208.10



Tomy Bar
Code No.: 507.116



Holding Forceps for Reaming Rod
Code No.: 507.06



Cannulated Extractor Impactor Set (Set of Three)
Code No.: 507.11



Cannulated Socket Wrench - 11mm
Code No.: 507.09



Conical Bolt with Two Nuts
Code No.: 507.13



Guide Rod / Reaming Rod Introducer
Code No.: 507.103



Proximal Jig
Code No.: 507.12



Curved Driving Piece with Head
Code No.: 507.10



Internal Fracture Alignment Device
Code No.: 507.115



Protection Sleeve, 8.0mm(ID), 11mm(OD)
Code No.: 507.17



Drill Sleeve, 4.5mm(ID), 8.0mm(OD)
Code No.: 507.19



Spanner 11mm, S.S.
Code No.: 507.99



Drill Sleeve 3.2mm(ID), 8.0mm(OD)
Code No.: 507.18



Trocar
Code No.: 507.113



Spanner 21mm, S.S.
Code No.: 507.1001



Drill Bit 4.0 x 4.5mm Dia. (Quick Coupling), Length 250mm.
Code No.: 260.501



Drill Bit 3.2mm Dia. (Quick Coupling), Length 200mm.
Code No.: 260.325

□ OPTIONAL INSTRUMENTS FOR UNIVERSAL NAILS

(To be Ordered Separately)



Distal Jig for Universal Tibial Nails
Code No.: 507.160



Distal Jig for Universal Femur Nails
Code No.: 507.162



Base Plate (for both Universal Tibial & Universal Femoral)
Code No.: 507.165



Sliding Sleeves (for Universal Tibial & Universal Femur Proximal Jig Assembly)
Code No.: 507.167



GAAM NAIL - LONG

Length in mm.	STAINLESS STEEL		
	120°	125°	130°
Shaft 11mm			
340	G.11.120.340	G.11.125.340	G.11.130.340
360	G.11.120.360	G.11.125.360	G.11.130.360
380	G.11.120.380	G.11.125.380	G.11.130.380
400	G.11.120.400	G.11.125.400	G.11.130.400
420	G.11.120.420	G.11.125.420	G.11.130.420
440	G.11.120.440	G.11.125.440	G.11.130.440
Shaft 12mm			
340	G.12.120.340	G.12.125.340	G.12.130.340
360	G.12.120.360	G.12.125.360	G.12.130.360
380	G.12.120.380	G.12.125.380	G.12.130.380
400	G.12.120.400	G.12.125.400	G.12.130.400
420	G.12.120.420	G.12.125.420	G.12.130.420
440	G.12.120.440	G.12.125.440	G.12.130.440
Shaft 13mm			
340	G.13.120.340	G.13.125.340	G.13.130.340
360	G.13.120.360	G.13.125.360	G.13.130.360
380	G.13.120.380	G.13.125.380	G.13.130.380
400	G.13.120.400	G.13.125.400	G.13.130.400
420	G.13.120.420	G.13.125.420	G.13.130.420
440	G.13.120.440	G.13.125.440	G.13.130.440

Fixation with 6mm Locking Bolt & Lag Screw

GAAM NAIL - LONG

Length in mm.	TITANIUM		
	120°	125°	130°
Shaft 11mm			
340	Ti-G.11.120.340	Ti-G.11.125.340	Ti-G.11.130.340
360	Ti-G.11.120.360	Ti-G.11.125.360	Ti-G.11.130.360
380	Ti-G.11.120.380	Ti-G.11.125.380	Ti-G.11.130.380
400	Ti-G.11.120.400	Ti-G.11.125.400	Ti-G.11.130.400
420	Ti-G.11.120.420	Ti-G.11.125.420	Ti-G.11.130.420
440	Ti-G.11.120.440	Ti-G.11.125.440	Ti-G.11.130.440
Shaft 12mm			
340	Ti-G.12.120.340	Ti-G.12.125.340	Ti-G.12.130.340
360	Ti-G.12.120.360	Ti-G.12.125.360	Ti-G.12.130.360
380	Ti-G.12.120.380	Ti-G.12.125.380	Ti-G.12.130.380
400	Ti-G.12.120.400	Ti-G.12.125.400	Ti-G.12.130.400
420	Ti-G.12.120.420	Ti-G.12.125.420	Ti-G.12.130.420
440	Ti-G.12.120.440	Ti-G.12.125.440	Ti-G.12.130.440
Shaft 13mm			
340	Ti-G.13.120.340	Ti-G.13.125.340	Ti-G.13.130.340
360	Ti-G.13.120.360	Ti-G.13.125.360	Ti-G.13.130.360
380	Ti-G.13.120.380	Ti-G.13.125.380	Ti-G.13.130.380
400	Ti-G.13.120.400	Ti-G.13.125.400	Ti-G.13.130.400
420	Ti-G.13.120.420	Ti-G.13.125.420	Ti-G.13.130.420
440	Ti-G.13.120.440	Ti-G.13.125.440	Ti-G.13.130.440



YouTube www.TV.ortho.in/28339

GAAM NAIL - SHORT

Length in mm.	STAINLESS STEEL		
	120°	125°	130°
Shaft 11mm			
180	G.11.120.180	G.11.125.180	G.11.130.180
200	G.11.120.200	G.11.125.200	G.11.130.200
220	G.11.120.220	G.11.125.220	G.11.130.220
Shaft 12mm			
180	G.12.120.180	G.12.125.180	G.12.130.180
200	G.12.120.200	G.12.125.200	G.12.130.200
220	G.12.120.220	G.12.125.220	G.12.130.220
Shaft 13mm			
180	G.13.120.180	G.13.125.180	G.13.130.180
200	G.13.120.200	G.13.125.200	G.13.130.200
220	G.13.120.220	G.13.125.220	G.13.130.220

Fixation with 6mm Locking Bolt & Lag Screw

GAAM NAIL - SHORT

Length in mm.	TITANIUM		
	120°	125°	130°
Shaft 11mm			
180	Ti-G.11.120.180	Ti-G.11.125.180	Ti-G.11.130.180
200	Ti-G.11.120.200	Ti-G.11.125.200	Ti-G.11.130.200
220	Ti-G.11.120.220	Ti-G.11.125.220	Ti-G.11.130.220
Shaft 12mm			
180	Ti-G.12.120.180	Ti-G.12.125.180	Ti-G.12.130.180
200	Ti-G.12.120.200	Ti-G.12.125.200	Ti-G.12.130.200
220	Ti-G.12.120.220	Ti-G.12.125.220	Ti-G.12.130.220
Shaft 13mm			
180	Ti-G.13.120.180	Ti-G.13.125.180	Ti-G.13.130.180
200	Ti-G.13.120.200	Ti-G.13.125.200	Ti-G.13.130.200
220	Ti-G.13.120.220	Ti-G.13.125.220	Ti-G.13.130.220



**END CAP FOR GAAM NAILS
STAINLESS STEEL**
Code No.: 051-SS



**END CAP FOR GAAM NAILS
TITANIUM**
Code No.: 051-Ti



**SET SCREW FOR GAAM NAILS
STAINLESS STEEL**
Code No.: 053-SS



**SET SCREW FOR GAAM NAILS
TITANIUM**
Code No.: 053-Ti

YouTube www.TV.ortho.in/28343

YouTube www.TV.ortho.in/28342

PROXIMAL FEMORAL NAILS ...LOCKING BOLTS & INSTRUMENTS SET FOR GAAM NAILS

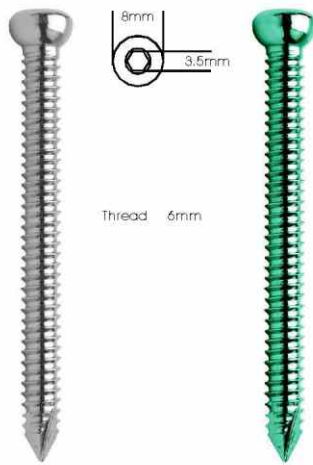

**GAAM NAIL LOCKING BOLT,
6 MM (SELF TAPPING)**

Length in mm	Code No. S.S.	Code No. TITANIUM
30	051-30	Ti-051-30
35	051-35	Ti-051-35
40	051-40	Ti-051-40
45	051-45	Ti-051-45
50	051-50	Ti-051-50
55	051-55	Ti-051-55
60	051-60	Ti-051-60
65	051-65	Ti-051-65
70	051-70	Ti-051-70
75	051-75	Ti-051-75
80	051-80	Ti-051-80
85	051-85	Ti-051-85
90	051-90	Ti-051-90
95	051-95	Ti-051-95
100	051-100	Ti-051-100
105	051-105	Ti-051-105
110	051-110	Ti-051-110
115	051-115	Ti-051-115
120	051-120	Ti-051-120

[YouTube www.TV.ortho.in/28340](http://www.TV.ortho.in/28340)



GAAM NAIL LAG SCREW

Length in mm	Code No. S.S.	Code No. TITANIUM
50	052-50	Ti-052-50
55	052-55	Ti-052-55
60	052-60	Ti-052-60
65	052-65	Ti-052-65
70	052-70	Ti-052-70
75	052-75	Ti-052-75
80	052-80	Ti-052-80
85	052-85	Ti-052-85
90	052-90	Ti-052-90
95	052-95	Ti-052-95
100	052-100	Ti-052-100
105	052-105	Ti-052-105
110	052-110	Ti-052-110
115	052-115	Ti-052-115
120	052-120	Ti-052-120
125	052-125	Ti-052-125

[YouTube www.TV.ortho.in/28341](http://www.TV.ortho.in/28341)

□ GAAM NAILS INSTRUMENTS SET, S.S.

AS050 INSTRUMENTS SET FOR GAAM NAIL, S.S.

Set Consisting of:		Units	Set Consisting of:		Units
509.01	Tissue Protector Sleeve, 17mm	1	509.11	Cannulated Drill Bit, 12mm	2
509.02	Guide Wire Sleeve 2.5mm	1	509.12	T-Wrench	1
509.03	Reamer, 17mm	1	509.13	Coupling Screw for T-Wrench	1
509.04	Radiolucent Jig	1	509.14	Distal Proximal Sleeve, 11mm	1
509.05	Nail Holding Bolt	1	509.15	Drill Sleeve, 5.2 mm	1
509.06	Driving Head	1	509.16	Trocar Sleeve	1
509.07	Extension Rod	1	509.17	Screw Driver, Extra Long, 3.5mm Tip	1
509.08	Slotted Hammer	1	509.18	Guide Wire - 2.5mm Dia., 350mm Long	4
509.09	Proximal Sleeve, 14mm	1	509.19	Drill Bit, 5.2 mm	2
509.10	Proximal Wire Sleeve, 2.5mm	1	903.090	Empty Container	



1 Lateral to Medial Hole for 4.5 mm Locking Bolt

1 Lesser Trochanter to Neck Hole for 8 mm Cannulated Locking Bolt

1 Lesser Trochanter to Neck Hole for 6 mm Cannulated Locking Bolt



1 Lateral to Medial Hole for 4.5 mm Locking Bolt

1 Lesser Trochanter to Neck Hole for 8 mm Cannulated Locking Bolt

1 Lesser Trochanter to Neck Hole for 6 mm Cannulated Locking Bolt

PROXIMAL FEMORAL NAIL (PFN)

Code S.S.	Dia. in mm	Length in cm	Code TITANIUM
PFN09-25	9	25	Ti-PFN09-25
PFN10-25	10	25	Ti-PFN10-25
PFN11-25	11	25	Ti-PFN11-25
PFN12-25	12	25	Ti-PFN12-25
PFN09-30	9	30	Ti-PFN09-30
PFN10-30	10	30	Ti-PFN10-30
PFN11-30	11	30	Ti-PFN11-30
PFN12-30	12	30	Ti-PFN12-30

Same Nail for Right & Left Leg.
Use with Instrument Set - AS079M

YouTube www.TV.ortho.in/145



RECON NAIL (LEFT)

Length in cm.	STAINLESS STEEL - Diameter in mm			
	9 mm	10 mm	11 mm	12 mm
34	RN09-34L	RN10-34L	RN11-34L	RN12-34L
36	RN09-36L	RN10-36L	RN11-36L	RN12-36L
38	RN09-38L	RN10-38L	RN11-38L	RN12-38L
40	RN09-40L	RN10-40L	RN11-40L	RN12-40L
42	RN09-42L	RN10-42L	RN11-42L	RN12-42L
44	RN09-44L	RN10-44L	RN11-44L	RN12-44L
46	RN09-46L	RN10-46L	RN11-46L	RN12-46L

Use with Instrument Set - AS079M

RECON NAIL (LEFT)

Length in cm.	TITANIUM - Diameter in mm			
	9 mm	10 mm	11 mm	12 mm
34	Ti-RN09-34L	Ti-RN10-34L	Ti-RN11-34L	Ti-RN12-34L
36	Ti-RN09-36L	Ti-RN10-36L	Ti-RN11-36L	Ti-RN12-36L
38	Ti-RN09-38L	Ti-RN10-38L	Ti-RN11-38L	Ti-RN12-38L
40	Ti-RN09-40L	Ti-RN10-40L	Ti-RN11-40L	Ti-RN12-40L
42	Ti-RN09-42L	Ti-RN10-42L	Ti-RN11-42L	Ti-RN12-42L
44	Ti-RN09-44L	Ti-RN10-44L	Ti-RN11-44L	Ti-RN12-44L
46	Ti-RN09-46L	Ti-RN10-46L	Ti-RN11-46L	Ti-RN12-46L

Use with Instrument Set - AS079M



RECON NAIL (RIGHT)

Length in cm.	STAINLESS STEEL - Diameter in mm			
	9 mm	10 mm	11 mm	12 mm
34	RN09-34R	RN10-34R	RN11-34R	RN12-34R
36	RN09-36R	RN10-36R	RN11-36R	RN12-36R
38	RN09-38R	RN10-38R	RN11-38R	RN12-38R
40	RN09-40R	RN10-40R	RN11-40R	RN12-40R
42	RN09-42R	RN10-42R	RN11-42R	RN12-42R
44	RN09-44R	RN10-44R	RN11-44R	RN12-44R
46	RN09-46R	RN10-46R	RN11-46R	RN12-46R

Use with Instrument Set - AS079M

RECON NAIL (RIGHT)

Length in cm.	TITANIUM - Diameter in mm			
	9 mm	10 mm	11 mm	12 mm
34	Ti-RN09-34R	Ti-RN10-34R	Ti-RN11-34R	Ti-RN12-34R
36	Ti-RN09-36R	Ti-RN10-36R	Ti-RN11-36R	Ti-RN12-36R
38	Ti-RN09-38R	Ti-RN10-38R	Ti-RN11-38R	Ti-RN12-38R
40	Ti-RN09-40R	Ti-RN10-40R	Ti-RN11-40R	Ti-RN12-40R
42	Ti-RN09-42R	Ti-RN10-42R	Ti-RN11-42R	Ti-RN12-42R
44	Ti-RN09-44R	Ti-RN10-44R	Ti-RN11-44R	Ti-RN12-44R
46	Ti-RN09-46R	Ti-RN10-46R	Ti-RN11-46R	Ti-RN12-46R

Use with Instrument Set - AS079M

YouTube www.TV.ortho.in/144

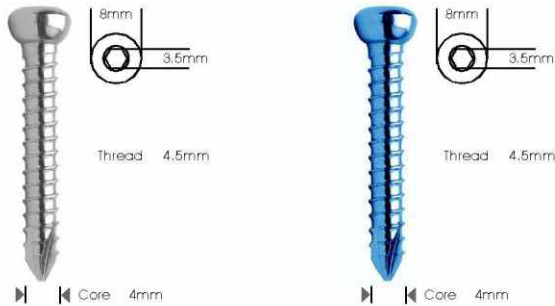

LOCKING BOLT, 4.5MM (SELF TAPPING)

Length in mm.	STAINLESS STEEL
24	045-24
26	045-26
28	045-28
30	045-30
32	045-32
34	045-34
36	045-36
38	045-38
40	045-40
42	045-42
44	045-44
46	045-46
48	045-48
50	045-50
55	045-55
60	045-60
65	045-65
70	045-70
75	045-75
80	045-80
85	045-85
90	045-90
95	045-95
100	045-100
105	045-105
110	045-110
115	045-115
120	045-120

Drill Bit : 4mm

Length in mm,	TITANIUM
24	Ti-045-24
26	Ti-045-26
28	Ti-045-28
30	Ti-045-30
32	Ti-045-32
34	Ti-045-34
36	Ti-045-36
38	Ti-045-38
40	Ti-045-40
42	Ti-045-42
44	Ti-045-44
46	Ti-045-46
48	Ti-045-48
50	Ti-045-50
55	Ti-045-55
60	Ti-045-60
65	Ti-045-65
70	Ti-045-70
75	Ti-045-75
80	Ti-045-80
85	Ti-045-85
90	Ti-045-90
95	Ti-045-95
100	Ti-045-100
105	Ti-045-105
110	Ti-045-110
115	Ti-045-115
120	Ti-045-120

Drill Bit : 4mm

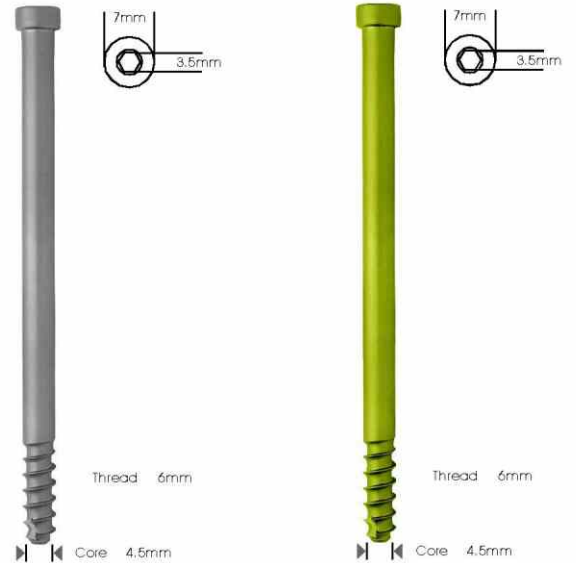

LOCKING BOLT, 6MM, CANNULATED (SELF TAPPING) FOR PFN & RECON NAILS

Length in mm.	STAINLESS STEEL
50	047-50
55	047-55
60	047-60
65	047-65
70	047-70
75	047-75
80	047-80
85	047-85
90	047-90
95	047-95
100	047-100
105	047-105
110	047-110
115	047-115
120	047-120

Cannulated Drill Bit: 4.5mm

Length in mm,	TITANIUM
50	Ti-047-50
55	Ti-047-55
60	Ti-047-60
65	Ti-047-65
70	Ti-047-70
75	Ti-047-75
80	Ti-047-80
85	Ti-047-85
90	Ti-047-90
95	Ti-047-95
100	Ti-047-100
105	Ti-047-105
110	Ti-047-110
115	Ti-047-115
120	Ti-047-120

Cannulated Drill Bit: 4.5mm



END CAP FOR PFN & RECON NAILS STAINLESS STEEL
Code No.: 047-SS



END CAP FOR PFN & RECON NAILS TITANIUM
Code No.: 047-Ti

YouTube www.TV.ortho.in/15422

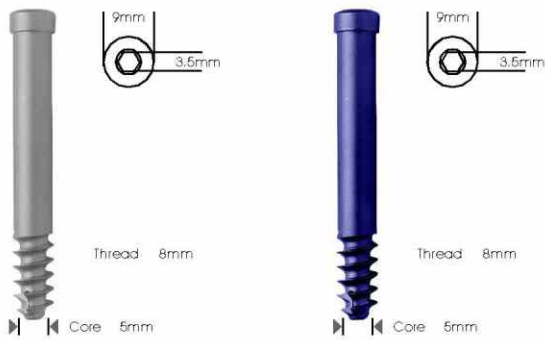

□ PFN & RECON NAILS IMPLANTS SET, S.S.



LOCKING BOLT 8MM CANNULATED (SELF TAPPING) FOR PFN & RECON NAILS

Length in mm.	STAINLESS STEEL
50	048-50
55	048-55
60	048-60
65	048-65
70	048-70
75	048-75
80	048-80
85	048-85
90	048-90
95	048-95
100	048-100
105	048-105
110	048-110
115	048-115
120	048-120

Cannulated Drill Bit: 5mm

Length in mm,	TITANIUM
50	Ti-048-50
55	Ti-048-55
60	Ti-048-60
65	Ti-048-65
70	Ti-048-70
75	Ti-048-75
80	Ti-048-80
85	Ti-048-85
90	Ti-048-90
95	Ti-048-95
100	Ti-048-100
105	Ti-048-105
110	Ti-048-110
115	Ti-048-115
120	Ti-048-120

Cannulated Drill Bit: 5mm

AS200 PFN & RECON NAILS (LEFT LEG) IMPLANTS SET, S.S.

Set Consisting of:

Units

PFN Nails

9mm Dia	
1 each, Length 25, 30cm	2
10mm Dia	
1 each, Length 25, 30cm	2
11mm Dia	
1 each, Length 25, 30cm	2
12mm Dia	
1 each, Length 25, 30cm	2

RECON Nails (Left Leg)

9mm Dia	
1 each, Length 34, 36, 38, 40, 42, 44cm	6
10mm Dia	
1 each, Length 34, 36, 38, 40, 42, 44cm	6
11mm Dia	
1 each, Length 34, 36, 38, 40, 42, 44cm	6
12mm Dia	
1 each, Length 34, 36, 38, 40, 42, 44cm	6

Locking Bolt 4.5mm Dia

5 each, Length 30, 32, 34, 36, 38, 40, 42, 44, 46, 48, 50, 55, 60mm	65
---	----

Cannulated Locking Bolt 6.0mm Dia

2 each, Length 60, 65, 70, 75, 100, 105, 110mm	14
5 each, Length 80, 85, 90, 95mm	20

Cannulated Locking Bolt 8.0mm Dia

2 each, Length 60, 65, 70, 75, 100, 105, 110mm	14
5 each, Length 80, 85, 90, 95mm	20

904.001 Empty Container for PFN & Recon Nails Implants Set

AS205 PFN & RECON NAILS (RIGHT LEG) IMPLANTS SET, S.S. (diameter and lengths as above)

Code No.: AS200 / AS205

□ INSTRUMENTS SET FOR PFN / RECON NAILS, S.S.



Code No.: AS079M

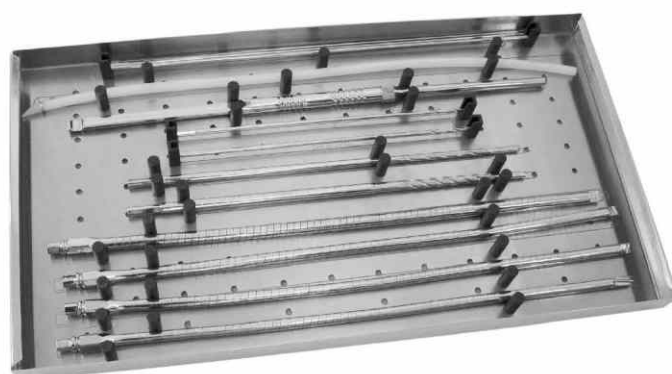
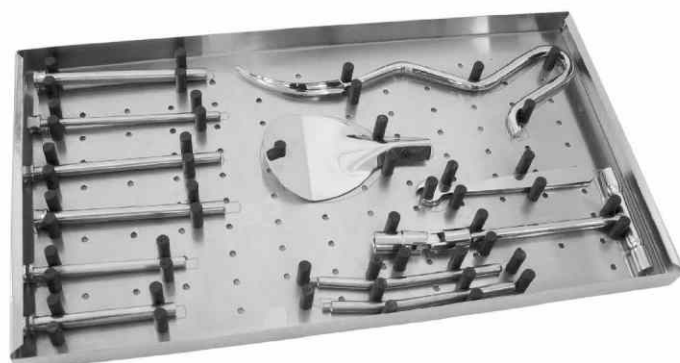

AS079M INSTRUMENTS SET FOR PFN / RECON NAILS, S.S.

Set Consisting of:

		Units
507.01	Diamond Pointed Bone Awl for Femoral	1
507.02	Tissue Protector	1
507.038	Flexible Reaming Shaft with Fixed Reamer, Dia. 8.0mm.	1
507.03	Flexible Reamer Shaft only (For Reamer Heads, 9, 9.5, 10, 10.5, 11, 11.5, 12, 12.5, 13mm.)	2
507.23	Flexible Reamer Shaft only (For Reamer Heads 13.5, 14, 14.5, 15mm.)	1
510.9 to 510.13	Reamer Heads (Medullary), 9, 9.5, 10, 10.5, 11, 11.5, 12, 12.5 & 13mm, Set of 9 pieces	1 Set
510.135 to 510.15	Reamer Heads (Medullary), 13.5, 14, 14.5, 15mm, Set of 4 pieces	1 Set
507.04	Medullary Tube	1
507.05	Reaming Rod 3.0mm Dia	1
507.103	Guide Rod / Reaming Rod Introducer	1
507.08	Guide Rod 3.0mm Dia	1
507.84	Extractor - Impactor	1
507.31	Protection Sleeve for 6mm Locking Bolts	1
507.32	Protection Sleeve for 8mm Locking Bolts	1
507.36	Guide Wire Sleeve, 2.0mm x 7.0mm	1
507.37	Guide Wire Sleeve, 2.0mm x 9.0mm	1
507.34	Threaded Guide Wire 2.0mm Dia.(6 pieces)	6
507.39	Cannulated Step Drill Bit for 6mm Cannulated Locking Bolt	1
507.40	Cannulated Step Drill Bit for 8mm Cannulated Locking Bolt	1
507.150	Proximal & Distal Jig for PFN/Recon Nail	1
507.106	Hex Cap	1
507.30	Proximal Jig Assembly Connecting Part	1
507.28	Hammering Device	1
507.152	Nail Holding Bolt for PFN & Recon Nails	2
507.48	Cannulated Hexagonal Screw Driver Extra Large - 3.5mm Tip	1
208.10	Extra Long Hexagonal Screw Driver 3.5mm Tip	1
507.16	Depth Gauge	1
507.110	Spanner 10mm, S.S.	1
507.61	Protection Sleeve, ID 8mm, OD 10mm for 4.5mm locking Bolt	1
507.64	Drill Sleeve 3.5mm ID, 8mm OD	1
507.24	Universal Socket Wrench, 10mm	1
507.116	Tomy Bar	2
261.637	Drill Bit, Dia 3.5mm x 250mm, Straight Shank, with Trocar End	2
902.010	Empty Container	



**Diamond Pointed Bone Awl
for Femoral**
Code No.: 507.01



Guide Rod / Reaming Rod Introducer
Code No.: 507.103



Medullary Tube
Code No.: 507.04



Extractor - Impactor
Code No.: 507.84



Depth Gauge (Extra Large)
Code No.: 507.16



Reaming Rod 3.0mm Dia.
Code No.: 507.05



Guide Rod 3.0mm Dia.
Code No.: 507.08



Drill Bit, Dia 3.5mm x 250mm, Straight Shank, with Trocar End
Code No.: 261.637



**Hexagonal Screw Driver
Extra Long - 3.5mm Tip**
Code No.: 208.10



**Cannulated Hexagonal Screw Driver
Extra Large - 3.5mm Tip**
Code No.: 507.48



Universal Socket Wrench, 10mm
Code No.: 507.24



Tissue Protector
Code No.: 507.02



Spanner, 10mm, S.S.
Code No.: 507.110



Tomy Bar
Code No.: 507.116



Flexible Reaming Shaft with Fixed Reamer, Dia. 8.0mm.
Code No.: 507.038



**Medullary Reamer
(Size: 9 to 15mm with 0.5mm difference)**
Code No.: 510.9 to 510.15

Flexible Reaming Shaft
Code No.: 507.03 (for Reamer Head 9 to 13mm)
Code No.: 507.23 (for Reamer Head 13.5 to 15mm)



**Cannulated Step Drill Bit
for 6mm Cannulated Locking Bolt**
Code No.: 507.39



**Cannulated Step Drill Bit
for 8mm Cannulated Locking Bolt**
Code No.: 507.40



Threaded Guide Wire 2.0mm Dia (6 Pcs.)
Code No.: 507.34



Drill Sleeve 3.5mm ID, 8mm OD
Code No.: 507.64



**Protection Sleeve, ID 8mm, OD 10mm
for 4.5mm locking Bolt**
Code No.: 507.61



Protection Sleeve for 6mm Locking Bolts
Code No.: 507.31



Guide Wire Sleeve for 2.0mm x 7.0mm
Code No.: 507.36



Protection Sleeve for 8mm Locking Bolts
Code No.: 507.32



Guide Wire Sleeve for 2.0mm x 9.0mm
Code No.: 507.37



Proximal & Distal Jig for PFN/RECON NAILS
Code No.: 507.150



Hex Cap
Code No.: 507.106



Nail Holding Bolt for PFN/RECON
Code No.: 507.152



Jig Assembly Connecting Part
Code No.: 507.30



Hammering Device
Code No.: 507.28

ASSEMBLY FOR PFN / RECON NAILS
(To be Ordered Separately)



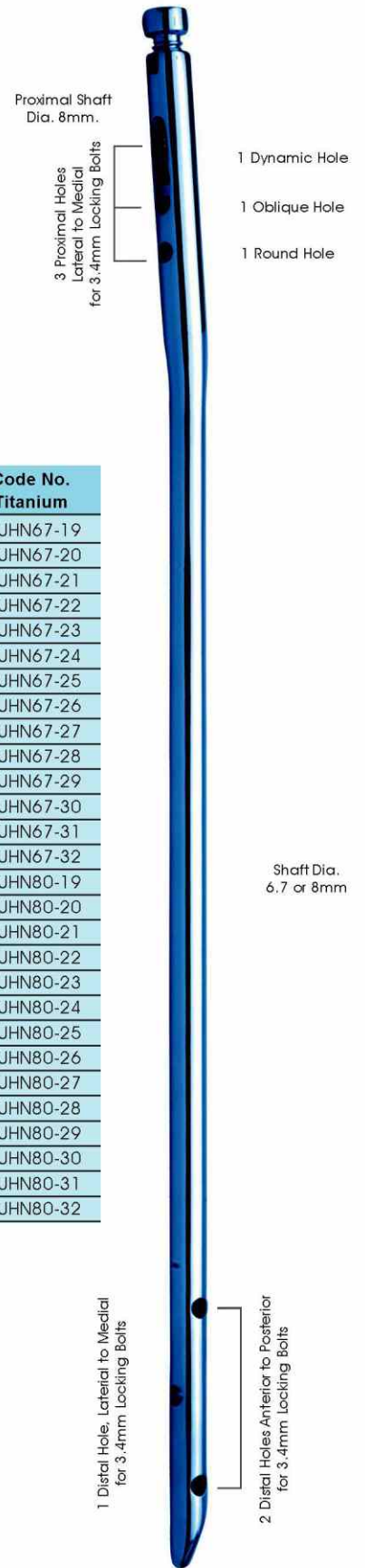
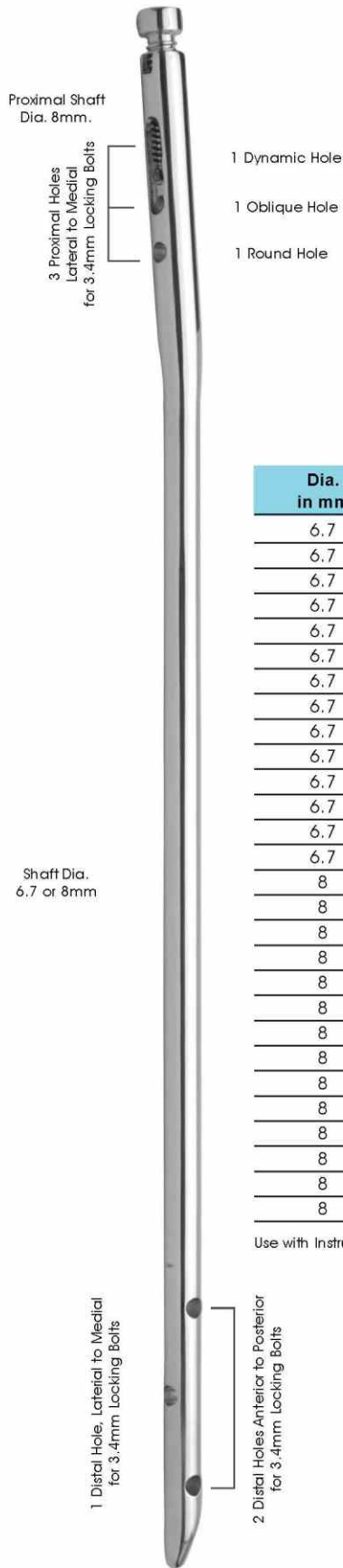

HUMERAL NAIL - UNREAMED

Dia. in mm	Length in mm	Code No. S.S.	Dia. in mm	Length in mm	Code No. Titanium
6.7	190	UHN67-19	6.7	190	TI-UHN67-19
6.7	200	UHN67-20	6.7	200	TI-UHN67-20
6.7	210	UHN67-21	6.7	210	TI-UHN67-21
6.7	220	UHN67-22	6.7	220	TI-UHN67-22
6.7	230	UHN67-23	6.7	230	TI-UHN67-23
6.7	240	UHN67-24	6.7	240	TI-UHN67-24
6.7	250	UHN67-25	6.7	250	TI-UHN67-25
6.7	260	UHN67-26	6.7	260	TI-UHN67-26
6.7	270	UHN67-27	6.7	270	TI-UHN67-27
6.7	280	UHN67-28	6.7	280	TI-UHN67-28
6.7	290	UHN67-29	6.7	290	TI-UHN67-29
6.7	300	UHN67-30	6.7	300	TI-UHN67-30
6.7	310	UHN67-31	6.7	310	TI-UHN67-31
6.7	320	UHN67-32	6.7	320	TI-UHN67-32
8	190	UHN80-19	8	190	TI-UHN80-19
8	200	UHN80-20	8	200	TI-UHN80-20
8	210	UHN80-21	8	210	TI-UHN80-21
8	220	UHN80-22	8	220	TI-UHN80-22
8	230	UHN80-23	8	230	TI-UHN80-23
8	240	UHN80-24	8	240	TI-UHN80-24
8	250	UHN80-25	8	250	TI-UHN80-25
8	260	UHN80-26	8	260	TI-UHN80-26
8	270	UHN80-27	8	270	TI-UHN80-27
8	280	UHN80-28	8	280	TI-UHN80-28
8	290	UHN80-29	8	290	TI-UHN80-29
8	300	UHN80-30	8	300	TI-UHN80-30
8	310	UHN80-31	8	310	TI-UHN80-31
8	320	UHN80-32	8	320	TI-UHN80-32

Use with Instrument Set - AS066

YouTube www.TV.ortho.in/153



- 1 Dynamic Hole
- 1 Oblique Hole
- 1 Round Hole

www.TV.ortho.in/166

HUMERAL NAIL - CANNULATED

Dia. in mm	Length in mm	Code No. S.S.
6.7	190	CHN67-19
6.7	200	CHN67-20
6.7	210	CHN67-21
6.7	220	CHN67-22
6.7	230	CHN67-23
6.7	240	CHN67-24
6.7	250	CHN67-25
6.7	260	CHN67-26
6.7	270	CHN67-27
6.7	280	CHN67-28
6.7	290	CHN67-29
6.7	300	CHN67-30
6.7	310	CHN67-31
6.7	320	CHN67-32
8.0	190	CHN80-19
8.0	200	CHN80-20
8.0	210	CHN80-21
8.0	220	CHN80-22
8.0	230	CHN80-23
8.0	240	CHN80-24
8.0	250	CHN80-25
8.0	260	CHN80-26
8.0	270	CHN80-27
8.0	280	CHN80-28
8.0	290	CHN80-29
8.0	300	CHN80-30
8.0	310	CHN80-31
8.0	320	CHN80-32

Use with Instrument Set - AS065



END CAP FOR HUMERAL NAIL

Dia. in mm	Ext. in mm	Codes S.S.
5.5	0.0	044.100
8.0	5.0	044.105
8.0	10.0	044.110
8.0	15.0	044.115

www.TV.ortho.in/128

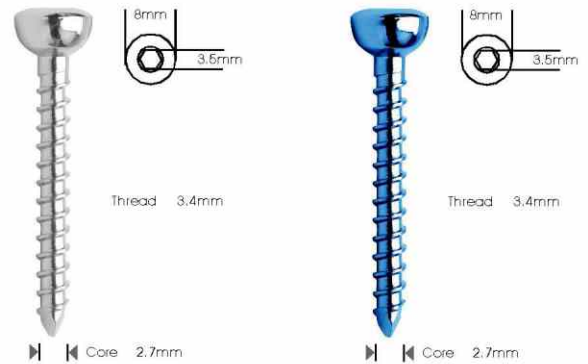

HUMERAL NAIL LOCKING BOLT

Length in mm	Code S.S.
20	043-20
22	043-22
24	043-24
26	043-26
28	043-28
30	043-30
32	043-32
34	043-34
36	043-36
38	043-38
40	043-40
42	043-42
44	043-44
46	043-46
48	043-48
50	043-50
52	043-52
54	043-54
56	043-56
58	043-58
60	043-60

Drill Bit: 2.7mm

3.4MM (SELF TAPPING)

Length in mm	Code Titanium
20	Ti-043-20
22	Ti-043-22
24	Ti-043-24
26	Ti-043-26
28	Ti-043-28
30	Ti-043-30
32	Ti-043-32
34	Ti-043-34
36	Ti-043-36
38	Ti-043-38
40	Ti-043-40
42	Ti-043-42
44	Ti-043-44
46	Ti-043-46
48	Ti-043-48
50	Ti-043-50
52	Ti-043-52
54	Ti-043-54
56	Ti-043-56
58	Ti-043-58
60	Ti-043-60

Drill Bit: 2.7mm



END CAP FOR HUMERAL NAIL

Dia. in mm	Ext. in mm	Codes Titanium
5.5	0.0	Ti-044.100
8.0	5.0	Ti-044.105
8.0	10.0	Ti-044.110
8.0	15.0	Ti-044.115

□ INSTRUMENTS SETS FOR HUMERAL NAILS

AS065 INSTRUMENTS SET FOR HUMERAL NAILS - CANNULATED

<i>Set Consisting of:</i>		Units
506.02	Proximal Jig	1
506.03	Cannulated Bone Awl	1
702.008	Slotted Hammer	1
506.05	Protection Sleeve 8mm (ID.), 11mm (OD.)	1
506.06	Drill Sleeve 2.7mm (ID.), 8mm (OD.)	1
506.07	Trocar 8mm	1
506.08	Depth Gauge	1
506.50	Cannulated Extractor/Impactor	1
507.98	Coupling Block for Extraction	1
506.56	Cannulated Nail Holding Bolt (Connecting Bolt)	1
506.57	Kirschner Wire with Trocar Tip 2.5mm Dia. x 300mm	1
703.015	Guide Wire with Threaded Tip, 2.0mm Dia x 230mm	1
201.28	Drill Bit Plain Shank, Trocar End, 2.7mm x 200mm	2
301.050	Large Hexagonal Screw Driver 3.5mm Tip	1
507.99	Spanner 11mm, S.S.	1
900.025	Empty Container	

AS066 INSTRUMENTS SET FOR HUMERAL NAILS - UNREAMED

<i>Set Consisting of:</i>		Units
506.02	Proximal Jig	1
506.03	Cannulated Bone Awl	1
702.008	Slotted Hammer	1
506.05	Protection Sleeve 8mm (ID.), 11mm (OD.)	1
506.06	Drill Sleeve 2.7mm (ID.), 8mm (OD.)	1
506.07	Trocar 8mm	1
506.08	Depth Gauge	1
506.09	Extractor/Impactor	1
507.98	Coupling Block for Extraction	1
506.11	Nail Holding Bolt (Connecting Bolt)	1
506.55	Kirschner Wire with Trocar Tip 2.0mm Dia. x 300mm	1
201.28	Drill Bit Plain Shank, Trocar End, 2.7mm x 200mm	2
301.050	Large Hexagonal Screw Driver 3.5mm Tip	1
507.99	Spanner 11mm, S.S.	1
900.025	Empty Container	

**OPTIONAL INSTRUMENTS
(To be Ordered Separately)**

<i>Set Consisting of:</i>		Units
506.12	Compression Device	1
506.13	Nail Holding Bolt for Compression	1
506.60	Cannulated Nail Holding Bolt for Compression	1
720.004	Projective Reamer	1
306.010	Quick Coupling Handle (T-Type)	1



Proximal Jig
Code No.: 506.02



Large Hexagonal Screw Driver - 3.5mm Tip
Code No.: 301.050



**Cannulated Nail Holding Bolt
(Connecting Bolt)**
Code No.: 506.56



Kirschner Wire with One Trocar Tip, 2.5mm Dia x 300mm
Code No.: 506.57



Guide Wire with Threaded Tip, 2.0mm Dia x 230mm
Code No.: 703.015

 www.TV.ortho.in/8187



Cannulated Bone Awl
Code No.: 506.03



Protection Sleeve 8mm(ID), 11mm(OD)
Code No.: 506.05



Drill Sleeve 2.7mm(ID), 8mm(OD)
Code No.: 506.06



Slotted Hammer
Code No.: 702.008



Coupling Block for Extraction
Code No.: 507.98



Cannulated Extractor / Impactor
Code No.: 506.50



Spanner 11mm, S.S.
Code No.: 507.99



Drill Bit, Plain Shank, Trocar End
2.7mm x 200mm
Code No.: 201.28



Depth Gauge
Code No.: 506.08

□ OPTIONAL INSTRUMENTS FOR HUMERAL NAILS

(To be Ordered Separately)



Compression Device
Code No.: 506.12



Cannulated Nail Holding Bolt for Compression
Code No.: 506.60



Projective Reamer
Code No.: 720.004



Quick Coupling Handle (T-Type)
Code No.: 306.010